



Electric Bicycle Owner's Manual

First Edition, 2023
Copyright, PeopleForBikes Coalition 2023

This manual meets EN ISO-4210, 16 CFR 1512 and EN 15194 Standards

IMPORTANT:

This manual contains important safety, performance and service information. Read it before you take the first ride on your new electric bicycle (e-bike), and keep it for reference.

Additional safety, performance and service information for specific components such as suspension or pedals on your e-bike, or for accessories such as helmets or lights that you purchase, may also be available. Make sure that your authorized retailer has given you all the manufacturers' literature that was included with your e-bike or accessories. In case of a conflict between the instructions in this manual and information provided by a component manufacturer, always follow the component manufacturer's instructions.

If you have any questions or do not understand something, take responsibility for your safety and consult with your authorized retailer or the e-bike's manufacturer.

NOTE: This manual is not intended as a comprehensive use, service, repair or maintenance manual. Please see your authorized retailer for all service, repairs or maintenance. Your authorized retailer may also be able to refer you to classes, clinics or books on bicycle use, service, repair or maintenance.

Questions? Contact us anytime:





Email: support@xtracycle.com | Phone/Text: 888-537-1401

Xtracycle (Priority Outdoor Products, LLC), 237 Shoreline Hwy, Mill Valley, CA 94941

GENERAL WARNING:

Like any sport, bicycling involves risk of injury and damage. By choosing to ride an e-bike, you assume the responsibility for that risk, so you need to know — and to practice — the rules of safe and responsible riding and of proper use and maintenance. Proper use and maintenance of your e-bike reduces risk of injury.

This Manual contains many “Warnings” and “Cautions” concerning the consequences of failure to maintain or inspect your e-bike and of failure to follow safe cycling practices.

- The combination of the  safety alert symbol and the word **WARNING** indicates a potentially hazardous situation which, if not avoided, could result in serious injury or death.
- The combination of the  fire hazard alert symbol and the word **WARNING** indicates a potentially hazardous situation which, if not avoided, could cause a sudden and severe fire, which could result in serious injury or death.
- The combination of the  trip hazard alert symbol and the word **WARNING** indicates a potentially hazardous situation which, if not avoided, could result in serious injury or death.
- The combination of the  safety alert symbol and the word **CAUTION** indicates a potentially hazardous situation which, if not avoided, could result in minor or moderate injury, or is an alert against unsafe practices.
- The combination of the  hot surface alert symbol and the word **CAUTION** indicates a potentially hazardous situation which, if not avoided, could result in burns.
- The word **CAUTION** used without the safety alert symbol indicates a situation which, if not avoided, could result in serious damage to the e-bike or the voiding of your warranty.

Many of the Warnings and Cautions say, “You may lose control and fall”. Because any fall can result in serious injury or even death, we do not always repeat the warning of possible injury or death.

Because it is impossible to anticipate every situation or condition that can occur while riding, this Manual makes no representation about the safe use of the e-bike under all conditions. There are risks associated with the use of any e-bike which cannot be predicted or avoided, and which are the sole responsibility of the rider.

FOR ASSEMBLY INSTRUCTIONS, PLEASE VISIT:

<https://xtracycle.com/pages/product-manuals>

Please be sure to review all additional owners manuals included with your bicycles.

Please continue to check our website for updated technical videos regarding this product.

Customer support is provided 365 days a year
Email: support@xtracycle.com | Phone/Text: 888-537-1401

Contents

1. Introduction	1
2. Safety Must Always Be First	1
A. How Is an E-bike Different from a Bicycle?	2
3. General Lithium-Ion Battery Safety	3
4. E-Bikes and Children: Attention Parents	4
A. How Old Should a Child Be to Operate an E-bike?	4
5. E-Bike Features and Functions	6
A. Electric Drive Systems	6
B. How Are E-bikes Classified and Regulated?	8
C. How Does an E-bike Provide Power?	9
D. Where Can I Ride My E-bike?	10
6. E-Bike Battery Safety	10
A. General Battery Knowledge and Safety	10
1. What is an e-bike battery?	11
B. Charging Your Battery	14
1. Before charging your battery	14
2. Recommended conditions for charging your battery	16
3. How to charge your battery	16
4. Storing your battery (long-term storage)	18
C. Transporting Your E-bike and Battery	19
1. Transporting on a car rack	19
2. Transporting on public transit	20
3. Transporting on an airplane	20
4. Shipping a battery	20
5. Disposing of your battery (end-of-life)	20
7. Safely Operating Your E-bike	22
A. Safety First	22
B. Mechanical Safety Check	22
C. Before Your First Ride	25
D. Before Every Ride	26
E. General E-bike Safety	27
F. Lighting and Night Riding	29
G. General Bicycle Safety	30
H. Riding Safety	31
I. Off-Road Safety	32
J. Wet-Weather Riding	32
K. Extreme, Stunt or Competition Riding	33
L. Changing Components or Adding Accessories	34
M. Walk-assist Mode	35
N. Getting the Most Out of Your E-bike	35

8. Best Practices for Riding and Carrying Passengers and Cargo	37
A. Riding with Passengers	38
B. Transporting Youth or Children	40
C. Transporting Cargo	41
1. Cargo e-bikes	41
D. Using a Trailer	42
9. Drive Systems	42
A. General Information About Your Drive System	42
10. Fit	43
A. Standover Height	44
1. Diamond-frame e-bikes	44
2. Step-through frame e-bikes	44
B. Saddle Position	44
C. Handlebar Height and Angle	46
D. Control Position Adjustments	48
E. Brake Reach	48
11. Tech	48
A. Wheels	48
1. Front wheel secondary retention devices	50
2. Wheels with cam-action systems	50
3. Thru-axle wheel mounting system	51
4. Removing and installing wheels	52
B. Seat Post Cam-action Clamp	56
C. Brakes	57
1. Brake controls and features	58
2. How brakes work	58
D. Shifting Gears	59
1. How a derailleur drivetrain works	59
2. How an internal gear hub drivetrain works	61
E. Pedals	61
F. Bicycle Suspension	62
G. Tires and Tubes	63
1. Tires	63
2. Tubeless rims and tires	64
3. Tire and rim width/diameter	65
4. Tire clearance	66
5. Tire valves	67
12. Maintaining and Servicing Your E-bike	68
A. Servicing the Electrical Drive System	68
B. Servicing the Mechanical Parts of Your E-bike	69
C. Service Intervals	70
D. If Your E-bike Sustains an Impact	72
Appendix A: The Lifespan of Your Bike and its Components	73
Appendix B: Fastener Torque Specifications	79
Appendix C: Xtracycle Passenger and Cargo Transit	80
Appendix D: Warranty	83

1. Introduction

IMPORTANT: We strongly urge you to read this Manual in its entirety before your first ride. This Manual is intended to be an instructional Manual for youth and adult e-bikes. An e-bike is a bicycle or tricycle that may be powered by the rider AND a drive system, which includes an electric motor, battery, controls, sensors, connective wiring and typically one or more displays.

In the United States, e-bikes have drive systems of less than 750 watts and a top assisted speed of not more than 28 mph/45 km/h. In other markets, e-bike (or pedelec) drive systems may be limited to 250 watts and pedal-assisted speed of no more than 15 mph/25 km/h. **Please note that not all e-bikes have all of the features described in this Manual. Ask your authorized retailer to point out the features of your e-bike.**

An e-bike has many of the mechanical features of an unpowered bicycle, with the addition of an electrical drive system. This manual addresses both the mechanical and electrical aspects of e-bikes, and the user needs to understand both aspects of their e-bike to use it safely.

 **WARNING: Ownership, operation, charging and maintenance of an e-bike involve certain risks and hazards, which can be minimized by following safe practices addressed in this Manual. Your knowledge of and adherence to those practices are essential to your safety, the safety of others, and the protection of property, including your e-bike.**

 **Carefully read the information in this Manual and the model-specific manuals included with your e-bike, in order to learn how to properly operate and maintain your e-bike, as well as avoid damage to your e-bike. Proper and safe operation of your e-bike is your responsibility.**

2. Safety Must Always Be First

 **WARNING: Read all instructions in this Manual, as well as the model-specific instructions and documents provided with your e-bike. Failure to read and follow the instructions and warnings provided in this Manual and by the manufacturer may result in electric shock, fire or a crash resulting in serious personal injury or death.**

 **WARNING: It is not recommended to ride an e-bike if the rider is too young to do so safely, or has any mental or physical impairments (seizures or any impairments related to cognitive or physical, vision, hearing or speaking) or other limitations that may prevent the safe operation of the e-bike. Parents and guardians should carefully review Page 4, Section 4: “E-bike and Children: Attention Parents” of this Manual before allowing any minor child to operate an e-bike. If unsure, consult your physician.**

 **WARNING: Never loan your e-bike to another person or let another person operate your e-bike unless they are familiar with the**

instructions and warnings in this Manual and competent to operate an e-bike. Allowing a person to operate an e-bike who lacks the knowledge or ability to safely do so may result in electric shock, fire or a crash, resulting in serious personal injury or death.

A. How Is an E-bike Different from a Bicycle?

The addition of a motor and electric drive system means e-bikes are very different from regular bicycles in several ways, and have different risks associated with their use. When riding an e-bike for the first time, be sure to familiarize yourself with your e-bike by reading all product documentation and reviewing the features with your authorized retailer. Following are the major differences between an e-bike and a regular bicycle:

- **General Battery Safety and Fire Risks:** E-bikes are equipped with an electric drive system, battery and charger, which pose a risk of electrical and fire hazards. Please refer to **Page 3, Section 3:** “General Lithium-Ion Battery Safety” and **Page 10, Section 6:** “E-bike Battery Safety” for additional information.
- **Children and Age Requirements:** Use of e-bikes by children and youth may present additional risks. Age restrictions for operating or being a passenger on an e-bike vary depending on the type of e-bike and on the country or region where the e-bike is located. Operation may be limited by the age of the rider, and local jurisdictions may have other requirements for e-bike operation such as the use of helmets. Please refer to **Page 4, Section 4:** “E-bike and Children: Attention Parents” for additional information.
- **Features, Functions and Restrictions on Use:** The addition of an electric drive system means e-bikes are different from regular bicycles, and you need to familiarize yourself with these differences. E-bikes are also regulated differently depending on their speed and power settings, and may have restrictions regarding where each type of e-bike can be ridden. These regulations and restrictions vary depending on your country or region. You must inform yourself of all applicable laws, requirements and restrictions. Please refer to **Page 6, Section 5:** “Features and Functions of your E-bike” for additional information on e-bike features, and **Page 10, Section 5(D):** for additional information on e-bike laws and where you can ride your e-bike.
- **Charging your E-bike:** Using proper charging practices and taking care of your e-bike and its battery will maximize your use and enjoyment of your e-bike. Please read all manufacturer instructions specific to your e-bike’s battery and charger, and also refer to **Page 10, Section 6:** “E-bike Battery Safety” for additional information.
- **Safely Operating your E-bike:** E-bikes are heavier, accelerate faster, can achieve higher speeds more quickly and maintain those speeds for longer periods of time compared to regular bicycles. These features can dramatically affect the handling, braking and cornering of your e-bike, which means you must exercise more caution around other people and when cornering, accelerating and slowing down. It is recommended that you get to know the functionality and intricacies of accelerating and decelerating your e-bike in an area away from people and cars/traffic. Please refer to **Page 22, Section 7:** “Safely Operating your E-bike” for additional information.

- **Riding with Passengers, Cargo and Trailers:** Many e-bikes are designed to carry cargo or passengers. Riding with the additional weight from cargo or passengers requires practice and particular attention to your surroundings when riding. Please refer to **Page 37, Section 8:** “Best Practices for Riding and Carrying Passengers and Cargo” for additional information.
- **Drive Systems:** The drive system on your e-bike is a sophisticated electronic system that requires special care and maintenance. Any service to the drive system should be performed by a qualified technician. Please refer to **Page 42, Section 9:** “Drive Systems” for additional information.

3. General Lithium-Ion Battery Safety

 **WARNING:** Before charging or using your e-bike, you must carefully read, understand and follow all information contained in **Page 10, Section 6: “E-Bike Battery Safety”** of this Manual about safety, handling, charging, transportation, storing and disposing of your e-bike battery. It is recommended that you periodically review this information to ensure you are following all recommendations for safe use of this product. Failure to read, understand and follow all battery safety warnings and instructions can cause a fire, leading to serious personal injury, death or property damage.

 **WARNING:** Lithium-Ion batteries are powerful and store a tremendous amount of energy. While they are generally designed with safety features to protect the battery and the user, they must be handled with special care. When damaged, improperly charged or misused, Lithium-Ion batteries are susceptible to an uncontrollable energy release resulting in a sudden and severe fire. A Lithium-Ion battery fire generally cannot be put out until the energy contained therein is exhausted. Therefore, proper use, charging, discharging, care, maintenance, storage and transportation are all critical to the long-term use of the battery and the safety of the user and others.

 **WARNING:** Do not leave a battery unattended while charging, especially overnight. Once the charge cycle is complete, immediately disconnect the charger plug from the battery. Do not leave the battery connected to the charger for an extended period of time after it has reached full charge. If a battery fails while left to charge unattended, the failure can get progressively worse, and can result in fire or explosion resulting in serious personal injury, death, or property damage.

 **WARNING:** NEVER open a Lithium-Ion battery pack or modify the wiring or any electrical components of any product powered by a Lithium-Ion battery. Opening the battery or modifying the wiring or components can result in electric shock and can cause a fire leading to serious personal injury, death, or property damage.

General Safety Guidelines for All Lithium-Ion Batteries:

ALWAYS: Purchase and use devices and batteries certified by an accredited testing laboratory.

ALWAYS: Follow the manufacturer's instructions for charging and storage.

ALWAYS: Use the correct battery, charger and cord.

ALWAYS: Plug directly into an electrical outlet for charging.

ALWAYS: Keep batteries and devices at room temperature.

ALWAYS: Store and charge batteries away from anything flammable.

ALWAYS: Keep batteries away from heat sources.

ALWAYS: Use proper methods for recycling old or damaged batteries.

NEVER: Use aftermarket or generic batteries or chargers.

NEVER: Plug into a power strip or overload an outlet.

NEVER: Overcharge or leave a battery charging overnight.

NEVER: Charge a battery or device on or close to any flammable material.

NEVER: Leave an e-bike or battery unattended while charging.

NEVER: Block your primary way in or out of a room or space.

NEVER: Place batteries in a trash or recycling bin.

4. E-Bikes and Children: Attention Parents

A. How Old Should a Child Be to Operate an E-bike?

This Manual covers e-bikes that may be used by both adults and older youth. The manufacturer of an e-bike cannot determine whether a particular child should or should not operate an e-bike. While e-bikes have a lot in common with regular bicycles, e-bikes also have a motor and battery, which means e-bikes weigh significantly more and can achieve significantly higher speeds, with much faster acceleration. A significant amount of strength and skill is required to safely control an e-bike. As a parent, you should read this Manual, as well as review its warnings and the e-bike's functions and operating procedures with your child before letting your child ride the e-bike.

While it is up to a parent or guardian to make the determination of whether their child can safely operate an e-bike, you should be aware of these general guidelines. According to the United States Consumer Product Safety Commission (CPSC), motorized bicycles require cognitive skills and motor skills that usually develop after age 12.

The CPSC's Age Determination Guidelines are available on their website at www.cpsc.gov.

Any youth or child riding an e-bike must have the necessary physical, mental and emotional capacity to ride the e-bike, as well as adequate bicycle riding experience and reaction time. They must also adhere to local laws, know how to manage different/changing road conditions, how to navigate traffic, and how to react quickly to unexpected situations.

NOTE: Local laws may vary regarding how old a child must be and what type of e-bike they can operate. It is up to the parents and child to conform to local laws.

 **WARNING:** A child should never ride an e-bike that is too big for them. While some e-bikes have step-through frames (see fig. 2) that may allow a child to mount an e-bike, that does not mean the e-bike is the right size for them to operate safely. An e-bike that is too big for a child may lead to a loss of control and fall, resulting in serious personal injury or death.

 **WARNING:** Some e-bikes may not be suitable for some children. Consult the documentation provided by the manufacturer of your e-bike for any information about age recommendations or restrictions. Parents must ultimately be responsible to determine whether their child is physically, mentally and emotionally capable of safely operating an e-bike, including understanding and following all warnings and instructions in this Manual. Allowing a child who lacks the capability to safely operate an e-bike to do so may lead to a crash resulting in serious personal injury or death.

 **WARNING:** Some states have age restrictions for transporting passengers. A child must be of age to ride an e-bike independently, or be of age as specified by the manufacturer to be a passenger on an e-bike, unless the child is in an approved child carrier that has been properly fitted. Transporting a child that does not meet the age/physical requirements to be a passenger and/or is not in an approved child carrier can result in serious personal injury or death.

Read all relevant passenger-related information provided with your e-bike, and consult with your authorized retailer for any additional information. Assessing the passenger's ability and safety is the parent's responsibility. If you're unsure, consult with your physician.

NOTE: For additional information regarding transporting passengers, please refer to **Page 37, Section 8:** "Best Practices for Riding and Carrying Passengers and Cargo".

 **WARNING:** A person must have the physical and mental ability to manage an e-bike in traffic, when facing varying road conditions or when in unexpected situations. They must also respect the laws of the road as they apply to bicycles. Failure to follow this warning could result in a crash leading to serious personal injury or death.

As a parent or guardian, you are responsible for the activities and safety of your minor child, including making sure that:

- your child wears a well-fitting and approved helmet at all times while operating or riding on the e-bike
- the e-bike is properly sized and fitted to your child
- the e-bike is in good repair and safe operating condition
- you and your child have learned and understand the safe operation of the e-bike as described in this Manual, and
- you and your child have learned, understand and obey not only the applicable local motor vehicle, e-bike and traffic laws, but also the common-sense rules of safe and responsible bicycling.

 **WARNING:** Make sure that your child always wears an approved bicycle helmet when riding. Also make sure that your child understands that a bicycle helmet is for riding only, and must be removed when not riding. A helmet must not be worn while playing, in play areas, on playground equipment, while climbing trees or at any time while not riding. Failure to follow this warning could result in serious personal injury or death.

 **WARNING:** Whether a child can safely operate an e-bike also depends on where the e-bike is being operated and the conditions present. Steep hills, wet or poor quality roads or trails, motor vehicle traffic, inclement weather, carrying passengers or cargo or other conditions may suddenly present risks that a child may lack the ability to respond to. The risks of operating an e-bike on public roads are different from operating an e-bike on natural-surface trails. Please read this Manual for more information on these risks and how to avoid them. Failure to follow this warning could lead to a crash resulting in serious personal injury or death.

5. E-Bike Features and Functions

E-bikes are manufactured by multiple companies and brands, each of which uses a variety of drive systems. These systems each have their own features and functions like motor and battery location, power output, battery capacity and maximum speed, as well as methods for charging and storing your battery and starting and operating the system. As such, you must familiarize yourself with the unique features and functions of your e-bike.

The e-bike-specific information included in this Manual covers universal topics shared by all e-bikes. For information that is specific to your e-bike, please refer to the model-specific manuals provided by your e-bike manufacturer, or consult your e-bike retailer or manufacturer.

Please refer to your authorized retailer or manufacturer for any questions about e-bike functions, local laws and regulations, parts compatibility, service intervals, as well as rider, cargo and passenger weight limits.

A. Electric Drive Systems

E-bikes differ from regular bikes with the addition of sophisticated components, engineered specifically for use on e-bikes. These components include:

- **Battery:** A sophisticated, high-performance, large-capacity Lithium-Ion battery, designed to safely contain a significant amount of energy and efficiently release it to the motor in order to supplement the rider's power output for long distances.
- **Motor:** Provides power assistance to the rider when the pedals are engaged. Certain types of e-bike are also equipped with a throttle to engage the power.
- **Controls:** Buttons located on the display, handlebar, battery and/or frame that allow the rider to choose the level of motor assistance while pedaling.
- **Sensors:** Detect forces being applied to the pedals or rotation of the pedals, provide information to the system to control power output.
- **Display(s):** Provide the rider with relevant information about the ride, such as speed, distance, power output, and battery charge (**fig. 1**).
- **Wiring system:** Connects the drive system components.

The addition of an integrated drive system means your e-bike is different from a regular bicycle. These differences mean you must follow all instructions in your manuals, and you should not treat your e-bike the same as a regular bicycle. This Manual will address how to handle and properly use an e-bike equipped with these unique components.

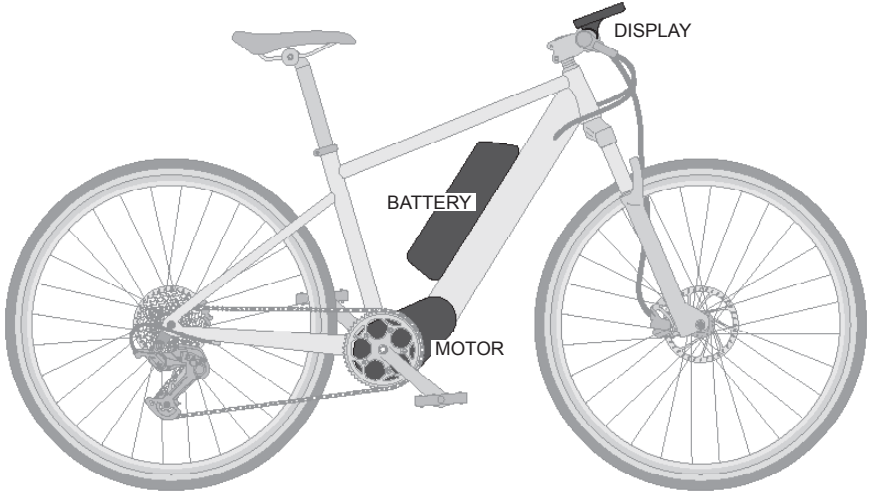

fig. 1
Typical mid-drive e-bike

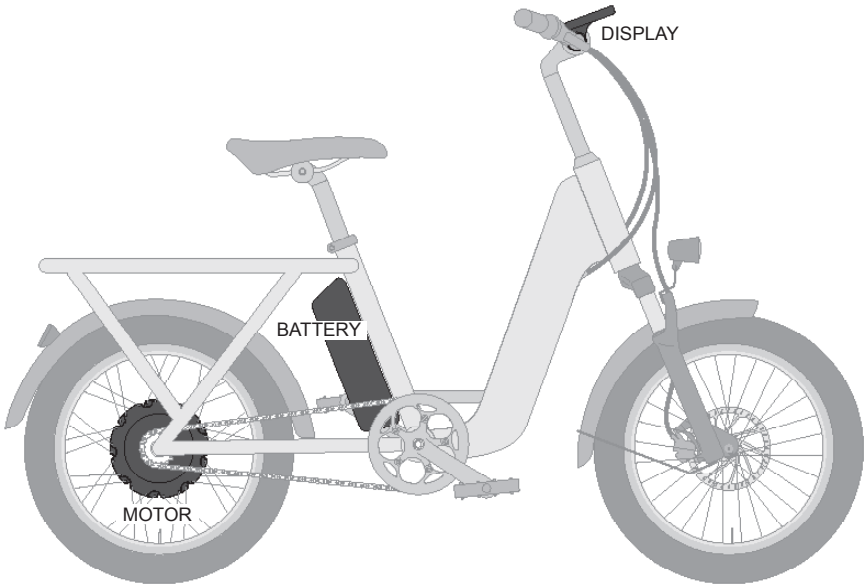

fig. 2
Typical hub drive e-bike

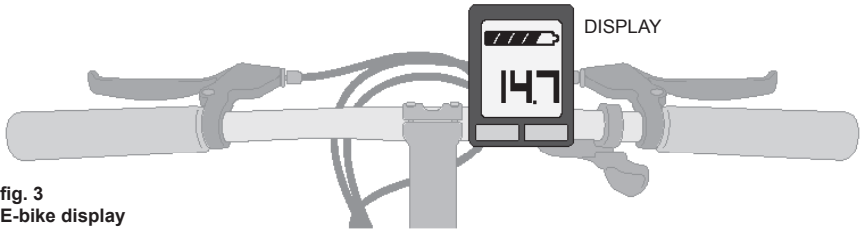

fig. 3
E-bike display

B. How Are E-bikes Classified and Regulated?

NOTE: The speed settings for your e-bike may be set according to the country or region where the e-bike is sold. Follow all national, regional and local regulations related to your e-bike. Following are some examples for how e-bikes are defined by country:

United States: Most states have defined three e-bike classes and regulate them within the state’s motor vehicle code. This gives riders similar rights and duties to that of regular bicycles. However, a few states regulate e-bikes in the same way as mopeds or a motor vehicle such as a car or motorcycle. Be sure to familiarize yourself with the laws relevant to your e-bike in your country and region, or ask your authorized retailer about these local laws.

- **Class 1:** Bicycle equipped with a motor that provides assistance only when the rider is pedaling, and that ceases to provide assistance when the electric bicycle reaches 20 mph (**fig. 1**).
- **Class 2:** Bicycle equipped with a throttle-actuated motor, that ceases to provide assistance when the electric bicycle reaches 20 mph (**fig. 2**).
- **Class 3:** Bicycle equipped with a motor that provides assistance only when the rider is pedaling, and that ceases to provide assistance when the electric bicycle reaches 28 mph.

NOTE: The speed settings for your e-bike may be set according to the region where the e-bike is sold. Follow all local/regional regulations related to your e-bike.

E-bike specifications can also include wattage (how much work a motor can do), torque (how much force the motor can apply) and battery watt hours (how long the battery will last or the typical range of the e-bike).

Europe: Under European regulations, an e-bike drive system only provides power when the pedals are engaged. This type of e-bike is typically referred to as an EPAC (Electronically Power Assisted Cycles or Electrically Power Assisted Cycles), EAPC (Electrically Assisted Pedal Cycles), or Pedelec (Pedal Electric Cycle).

Europe also recognizes a category of higher power and speed e-bikes known as the “Speed Pedelec”, or “S-Pedelec”. These e-bikes also provide power only when the rider is pedaling, but may have motor power up to 4000 watts and a top speed of up to 28 mph/45 km/h. European regulations for Speed Pedelecs require that certain components must be replaced with identical components, meaning ones that have been manufactured or approved by the manufacturer.

Speed Pedelecs are sometimes classified as motor vehicles, depending on local laws. This means that in those places some or all of the following may be required:

- A rear-view mirror
- A license plate
- Liability insurance, operating license or EU-type approval with insurance markings attached
- A minimum tire tread depth of 1 mm
- Tires replaced when worn with an identical (or approved) tire

When using a Speed Pedelec, the rider must be familiar with the local laws for riding on:

- Cycling paths
- Road lanes marked for moped access
- Cycling paths that allow mopeds
- Off-road trails
- Lanes that are closed to mopeds, motor vehicles or motorcycles
- Public roads, as well as on private property with permission by owner
- Pedestrian areas where regular bikes are allowed
- Parking in areas for regular bikes

As e-bike regulations are constantly being updated, it is your responsibility to stay up-to-date on the latest regulations (helmet use, age restrictions, requirements for license and insurance), as well as any restrictions for where you can ride your e-bike (roads, paths, parks or other facilities).

 **WARNING: Do not modify or alter your e-bike, or install additional equipment with the intention of increasing the performance and/or top speed of the e-bike. Modifying an e-bike to increase its performance or speed may be unlawful and can result in component failure or a loss of control, leading to a crash resulting in serious personal injury or death.**

NOTE: A modified e-bike may no longer be regulated as an e-bike, placing the operator at risk of personal liability and criminal prosecution in the event of a crash. Any alterations can negatively affect the lifespan of the e-bike and its components, and can result in damage to the drive system. It can also void the warranty of the e-bike.

C. How Does an E-bike Provide Power?

Pedal-assist is the power provided by the drive system to the rear wheel. For Class 1 and Class 3 e-bikes and Pedelecs, the drive system is designed so the power provided by the motor is dependent on pedal force being applied by the rider. The amount of power provided by the motor is determined by how hard or easy the rider is pedaling (the harder the rider pedals the more power the motor provides) in combination with the power-assist mode chosen by the rider, up to the maximum speed determined by the classification of the e-bike and the regulations put in place by the country where the e-bike is sold.

For Class 2 e-bikes, the pedal force and/or the throttle may determine the amount of power supplied by the drive motor to the rear wheel.

NOTE: This Manual is only for e-bikes that are manufactured as complete e-bikes and designed to apply power through the rear wheel, with either a “mid-drive” motor (**fig. 1**) or motor contained in the rear hub (**fig. 2**). This Manual does not cover other types of e-bikes, including front-wheel drive, conversion kits, or “add-on” electric motors of any kind.

D. Where Can I Ride My E-bike?

The Three-Class Approach

In the United States, state and local governments have the authority to determine where e-bikes can be operated, including restricting their use. It is recommended to check the rules and regulations for your e-bike class that apply where you live and/or ride. In most states, e-bikes are regulated using a three-class approach:

- Class 1 e-bikes, when regulated in the same way as regular bikes, can generally be used in the same places as regular bikes, including but not limited to bike paths, lanes, routes and protected lanes.
- Class 2 e-bikes, while often similar to Class 1 e-bikes, also include the addition of a throttle which allows the use of the e-bike without pedaling. This fundamental difference can impact and/or limit where a Class 2 e-bike can be ridden.
- Class 3 e-bikes may have greater limitations due to their higher power-assisted speed. Use on bike paths, lanes, routes and protected lanes may not be allowed.

NOTE: In Canada, Europe and other countries, national, regional and local laws determine which types of e-bikes are allowed and where an e-bike of each type may be operated. As these laws can be subject to frequent changes, you should consult and comply with your local laws.

Off-Road Respect

Additionally, off-road trail access is sometimes restricted to use only on trails that allow for motorized vehicle use. Off-road e-bikes, often referred to as eMTBs, may not be permitted for use on your local trails, or only Class 1 e-bikes may be allowed. As local land use rules change frequently, be sure to consult with your local land manager.

Obey the local laws regulating where and how you can ride off-road, and respect private property. You may be sharing the trail with others — hikers, trail runners, equestrians and other cyclists. Respect their rights. Stay on the designated trail. Don't contribute to erosion by riding in mud or with unnecessary sliding or skidding. Don't disturb the ecosystem by cutting your own trail or shortcut through vegetation or streams. It is your responsibility to minimize your impact on the environment. Leave things as you found them; and always take out everything you brought in.

6. E-Bike Battery Safety

A. General Battery Knowledge and Safety

 **WARNING:** Carefully read this section and Page 3, Section 3: “General Lithium-Ion Battery Safety” before using your e-bike or charging the battery. Improper use, storage or charging of the battery can cause thermal runaway leading to a sudden and severe fire resulting in property damage, serious personal injury or death.

1. What is an e-bike battery?

An e-bike battery consists of a series of Lithium-Ion cells designed to contain electric energy. The charge and release of energy in the cells is managed and controlled by internal circuitry. The cells and circuitry are contained in a housing or shell, also known as a battery pack, which is designed to protect the cells and internal circuitry and interface with a mounting mechanism on your e-bike.

E-bike batteries store a tremendous amount of energy for their small size and light weight. While batteries are generally designed with safety features to protect the battery and its user and failure is therefore unlikely, it's not impossible so they must be handled with special care.

When damaged or improperly used, Lithium-Ion batteries are susceptible to an uncontrollable energy release. This means there is a risk of a sudden and severe fire, and a Lithium-Ion battery fire generally cannot be put out until the energy contained therein is exhausted. Therefore, proper use, charge/discharge, care, maintenance, storage and transportation are critical to the long-term use of the battery and the safety of the user.



WARNING: Batteries and chargers are designed to be safe and reliable for their intended use. Failure to read and follow these instructions and use your battery as intended by the manufacturer can result in thermal runaway, resulting in a sudden and severe fire and serious personal injury or death, as well as significant property damage. Please follow the guidelines below to minimize the risk of battery pack failure:

- **Only** use the battery supplied with your e-bike, or a replacement battery that is designed specifically for use with your e-bike.
- **Only** use a charger that is supplied with your battery, or that is confirmed as compatible by the battery or e-bike manufacturer. **Do not** use other chargers or power supplies to charge your battery pack.
- **Do not** leave the battery unattended while charging, especially overnight. Once the battery is fully charged, disconnect the charger from the battery.
- **Do not** charge or store the battery in direct sunlight, or in an environment that is outside the temperature range specified by the battery manufacturer.
- **Do not** expose the battery to excessive heat from a flame or other heat source, or extended exposure to the sun.
- **Do not** expose the battery internals to water by submersion or strong water spray.
- **Do not** subject the battery to excessive weight from objects placed on the battery.
- **Do not** subject the battery to severe impact or shock from being dropped or struck by another heavy object.
- **Do not** subject the battery to excessive vibration.
- **Do not** use or attempt to charge a battery that has been dropped, damaged, or submersed in water.
- **Do not** open or deform the battery housing and/or perform any modifications or service to the battery. There are no user-serviceable components in the battery pack. Opening a Lithium-Ion battery may result in a hazardous condition that could lead to an explosion and/or fire, and will void the warranty.
- **Do not** short-circuit the battery terminals through contact with metal objects (e.g., nails, keys or screws).

- **Do not** touch severely corroded battery terminals.
- **Do not** apply solder to the terminals.

The following is a list of signs of battery damage, which can result in electric shock, short-circuit, fire and/or explosion:

- External battery casing damage (chips, cracks)
- Battery casing deformation (bulging)
- Battery casing or terminal discoloration
- Signs of corrosive (rust) damage from water entering the battery
- Plug connector damage or deformation
- Sounds, odors, smoke and/or flames emanating from the battery
- Battery fluid leak

 **WARNING: A battery should not exhibit any heat, flames, noises, odors, smoke, swelling, leaks, discoloration, deformation or other abnormalities. If a battery exhibits any of these symptoms and is failing catastrophically, evacuate all people from the area immediately and summon fire authorities (in the United States, call 911). Only if it is possible to do so safely and quickly should you attempt to move the battery outdoors and away from people or flammable materials.**

 **WARNING: If the battery is leaking, do not touch this liquid. Battery liquid can cause irritation or burns. If there is contact with battery liquid, rinse immediately with water. If the contact is with the eyes, seek medical attention immediately after rinsing.**

 **WARNING: If the battery is emitting any smoke or fumes, move to a place with proper ventilation. Fumes can irritate the respiratory system. If anyone is exposed to any smoke or fumes and experiencing negative effects, seek medical attention.**

 **WARNING: If your battery experiences a fault or error during use, charge or discharge, immediately stop using or charging the battery, check the manual provided by your manufacturer, and have the battery inspected and if necessary, replaced by your authorized retailer.**

CAUTION: Due to the natural process of transferring electricity and storing it inside the battery cells, the battery and charger housings can get hot while charging. Use caution when touching the battery and charger while charging. Additionally, the battery housing can get warm during use.

 **WARNING: Do not install the battery on the e-bike if the following circumstances are present:**

- The battery is not original to the e-bike or an exact replacement battery from the e-bike manufacturer that is fully compatible with the e-bike.
- The battery is damaged in any way.
- The battery has been exposed to excessive water or submersion.

Failure to follow these warnings may cause a fire resulting in property damage, serious personal injury or death.

NOTE: Ensure the battery contacts (connecting terminals or pins) that interface with the e-bike are clean. A dirty/contaminated interface can result in difficulty installing/removing the battery, or the battery getting stuck. Dirty or corroded battery terminals can cause a significant increase in resistance to current flow between the battery and the e-bike, resulting in significant heat build-up which will compromise range and may damage the battery and e-bike.

Clean the battery and electrical contacts using a soft, dry or lightly damp cloth to keep the battery free of dirt and debris. Do not expose the battery to harsh chemical cleaners or products. Do not use alkali- or acid-based solvents (e.g., rust cleaners).

If the charge port has a cover, close the cover after charging to keep the charge port terminals clean and dry.

 **WARNING: Keep the battery and charger away from children and animals. Unless supervised or instructed on proper/responsible use, children or people who lack the necessary experience or understanding to operate the battery and charger safely should not be left unattended with the battery and charger. There is a significant risk of personal injury and/or damage.**

 **WARNING: Turn the battery and e-bike off before installing or removing the battery. For information on battery installation and removal, please refer to the manufacturer's instructions for your e-bike model.**

 **WARNING: Do not attempt to install or remove the battery while riding.**

 **WARNING: Before transporting, storing or performing any work on your e-bike, remove the battery, or turn it off if the battery cannot be removed. A drive system with a battery installed can turn on unexpectedly, which can cause serious injury.**

 **WARNING: If installing components or accessories that require wiring or servicing your e-bike, it is recommended to remove the battery before performing the installation or service to avoid the risk of shock.**

 **WARNING: Do not pressure-wash your e-bike or battery with a hose or other pressure-washing device. If the battery is removable, remove the battery when cleaning your e-bike.**

 **WARNING: When handling components (especially the battery), handle with both hands. Failure to do so may result in dropping the component, which can result in personal injury and/or damage to the component.**

CAUTION: When using rack-mounted batteries, unless designed specifically for this purpose and approved by the manufacturer, do not use the rack or battery as a handle to lift the e-bike. This can result in damage to the battery.

Always make sure the battery is securely installed. If there's a lock, engage it and remove the key.

If your battery has a key, take note of the manufacturer and number of the

key. In the event of a lost key, please contact your authorized retailer. Familiarize yourself with the charge level indicator lights on your e-bike system, to know when it is at capacity, as well as if your battery is in danger of shutting off during use due to lack of battery power.

CAUTION: Do not discharge your battery completely (deep discharge) as this can damage the battery or shorten its useful life. A battery that runs out of power during a ride is functionally depleted. If it is left for an extended period of time (days) after being functionally depleted, it will naturally lose more power while not being used, which can lead to a state of deep discharge. This state of deep discharge can damage a battery resulting in significantly reduced energy capacity, and it can make it difficult to properly recharge, or worse, render it unserviceable, even with help from a qualified technician. After use and once cooled down, it is recommended to fully charge the battery in preparation for your next ride.

Pay particular attention to the specific charging habits, as well as the operating and storage temperatures recommended by the e-bike manufacturer. Lithium-Ion batteries have an ideal operating temperature range to maximize efficiency and performance. Exposure to extreme temperatures outside the manufacturer's specified range during charging, use or storage may negatively impact the efficiency, performance and lifespan of the battery, as well as damage to the drive system components. Lithium-Ion batteries are especially vulnerable to cold temperatures. The colder a battery is, the lower the energy capacity and range.

Unless explicitly stated by the manufacturer, Lithium-Ion batteries do not require a break-in period. They can also be turned off and connected or disconnected from the charger at any time regardless of the state of charge without damaging the battery.

If the battery will not be used for longer than a few days, if possible, disconnect the battery and remove it from the e-bike. This can help prevent a parasitic power drain.

 **WARNING: E-bike batteries are intended only as a power supply for approved e-bikes. Do not use e-bike batteries for any other applications. Use of an e-bike battery for other applications may create a risk of fire or electric shock.**

B. Charging Your Battery

 **WARNING: Carefully read, understand and follow all warnings and instructions for charging your battery. Failure to do so can lead to an electrical shock or sudden and severe fire, resulting in serious personal injury or death.**

1. Before charging your battery

Before using your e-bike or charging your battery for the first time, read all the instructions in this Manual and any product documentation included with your e-bike. Turn the battery power on according to the manufacturer's instructions.

This will help determine if the battery is charged, needs charging or is damaged. Batteries are generally shipped from the manufacturer with a partial charge. It is recommended to charge the battery to full capacity before your first use.

 **WARNING: Charging the battery when any of the conditions listed below are present can result in electric shock, serious personal injury, or damage to the battery or property. Do not connect the charger to the battery and charge the battery if any of the following circumstances are present:**

- The battery charge port terminals and/or the charger plug are contaminated. Repeatedly connecting contaminated terminals can result in worn and damaged terminals. Clean thoroughly before connecting the charger.
- The battery, battery charge port, charger or charger plug ends have been submerged or are wet. Additionally, do not handle the battery, charger or any charge port terminals with wet hands. Dry everything thoroughly before connecting the charger.
- The battery is in an area exposed to explosive materials (e.g., a fueling station), or is exposed to chemicals or other flammable particles in the air.
- The battery has been dropped, noticeably scratched or damaged in any way.
- The charger shows any signs of damage. Inspect before each use.

 **WARNING: Unless explicitly stated by the manufacturer, only use the charger indoors. Do not expose the e-bike, battery or charger to the rain and wind while charging. Exposure to water while charging may create a risk of electric shock or fire, resulting in serious personal injury, death or property damage.**

 **WARNING: Only use Original Equipment (OE) batteries and chargers that are compatible with each other, and have been specified and approved by the manufacturer for use with each other and with your e-bike. The charger, charge cord and power output cable must be specified for use with your battery. Use of an unapproved or counterfeit battery or charger can result in serious damage to the battery and/or components and can result in a sudden and severe fire or explosion resulting in serious bodily injury or death.**

 **WARNING: Do not modify or open the charger. Opening or modifying the charger can result in electric shock or damage to the internal circuitry that is designed to reduce the risk of thermal runaway, leading to a fire resulting in serious personal injury, death or property damage.**

 **WARNING: Do not touch the terminals of the battery or charger during an electrical storm in case of a lightning strike.**

 **WARNING: Handle the charger and power cables with care. Do not tightly bundle, apply excessive tension (pull force) or carry by the cables. Do not wash the charger.**

2. Recommended conditions for charging your battery



WARNING: Carefully read, understand and follow all manufacturer warnings and instructions for charging your battery. Batteries are sophisticated devices that require proper charging conditions. When charging a battery, ensure all the conditions below are present. Failure to do so can lead to an electrical shock or sudden and severe fire, resulting in serious personal injury or death.

- The battery and charger are compatible with each other and the e-bike.
- The battery is being charged during daylight hours and where it can be observed in case of any indication of odor, smoke, fumes or fire.
- The charging area is protected from the elements, dry, well-ventilated, and has a smoke detector. If you charge your battery indoors, do not do it in a bedroom or any place blocking egress from the area. A charging battery cannot be left unattended and must be observed at all times while charging.
- The battery is on a clean, dry and flat, non-flammable surface, preferably metal, ceramic or glass.
- The battery and the charge port connectors (terminals or pins) are dry, clean and free of debris.
- The battery and charger have no items covering or placed on top impeding airflow around these components.
- The battery is not exposed to flammable materials or an open flame.
- The ambient temperature around the battery and charger is in the charging temperature range specified by the manufacturer.
- The rated voltage capacity from the power source (electrical outlet) matches the charger.
- The charger's outlet plug and battery connector plug are both fully inserted into the electrical outlet and the battery's charge port.
- The charger's fan vent is unobstructed (chargers with built-in fans).
- Do not use a power converter, for example to convert 220 volts to 110 volts.

3. How to charge your battery

Follow the order of operations for connecting the charger and charging the battery (**fig. 4**) as outlined by your e-bike manufacturer. An improperly connected charger can result in damage to the drive system components.

- Remove the charge port cover (if present).
- Connect the charger to the battery and the power outlet, in the order specified by the manufacturer.
- Once charging begins, periodically refer to the indicator lights on the charger and e-bike's charge level display for power level information.
- Once the indicator lights indicate a full charge, immediately disconnect the charger from the power outlet and the battery, in the order specified by the manufacturer.
- Replace the charge port cover (if present).
- If the battery will not be used right away, store the battery as outlined on **Page 18, Section 6: "E-bike Battery Safety", subsection B.4: "Storing Your Battery"**.

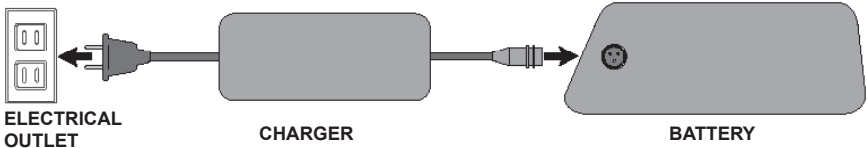

fig. 4
Charger and battery

WARNING: Do not leave a battery unattended while charging, especially overnight. Once the charge cycle is complete, immediately disconnect the charger plug from the battery. Do not leave the battery connected to the charger for an extended period of time after it has reached full charge. If a battery fails while left to charge unattended, the failure can get progressively worse, and can result in fire or explosion resulting in serious personal injury, death, or property damage.

WARNING: Do not ride the e-bike with the charger plugged into the battery.

WARNING: Do not move the e-bike or allow it to fall while it's charging. Make sure the e-bike is stable and cannot move easily. If the plug comes loose during the charging process, it can cause an electrical spark leading to a fire, resulting in serious personal injury or property damage.

WARNING: TRIP HAZARD! When charging, be aware of the location of the charger cable. Tripping over the charger cable can result in a fall, leading to personal injury or cause the e-bike to fall over, resulting in property damage.

WARNING: Do not use a power inverter to charge the battery from a 12-volt automobile auxiliary power outlet in a vehicle. Incorrect or excessive voltage can result in overheating, which can damage the battery and reduce the battery's lifespan or cause a sudden and severe fire resulting in serious personal injury or property damage.

CAUTION: Do not remove the battery from the e-bike during the charging process. If the battery has to be removed, first end the charging process before removing the battery from the e-bike, then once the battery is in a proper state for charging, restart the charging process.

E-bike batteries have temperature sensors that prevent charging when outside of the range specified by the manufacturer. Please refer to the manufacturer's specifications for additional information.

If the battery is being charged outside the recommended temperature range, the battery will indicate a charging issue. If the battery is not charging, disconnect the charger and adjust the conditions so the temperature is within the specified range. Only reconnect the charger once the battery is within the specified temperature range.

If the conditions for charging are all correct but the battery is not charging, or it's not fully charged hours after the manufacturer's specified charge time, disconnect the charger and have the battery and charger inspected by your authorized retailer.



WARNING: If the battery becomes too hot, starts to emit smoke or a strong odor, shows any signs of deformation/bulging, or otherwise presents unusual characteristics, discontinue use of the battery. If a battery exhibits any of these symptoms and is failing catastrophically, evacuate the area immediately and call fire authorities. Only if possible to do so safely and quickly should you attempt to move the battery outdoors and away from people and flammable materials.

4. Storing your battery (long-term storage)

Even under the best of circumstances, the energy storage capacity of Lithium-Ion batteries gradually degrades over time and with each charging cycle. However, by following proper care and storage habits as specified by the manufacturer, you can maximize the lifespan of the battery. Please read and follow the storage recommendations below.

If the battery will be in storage for an extended period of time, it is recommended the battery be stored with a partial charge, and the state of charge should be checked periodically in accordance with the manufacturer's specifications. If the state of charge has dropped below the manufacturer's recommended range, charge it back to within the range. Please refer to the manufacturer specifications for additional information.

CAUTION: A battery that is stored while functionally depleted, if left in that state for an extended period of time, will naturally lose more power while not being used, which can lead to a state of deep discharge. This state of deep discharge can damage a battery resulting in significantly reduced energy capacity, which can make it difficult to properly recharge, or worse, render it unserviceable, even with help from a qualified technician.

To optimize battery storage conditions, it's especially important that they be kept indoors in a temperature and climate-controlled environment whenever possible. Ensure the following conditions are present:

- The battery is separated from the e-bike (if possible). If the battery is integrated in the frame, the whole e-bike should be stored indoors.
- The storage area is protected from the elements, dry, well-ventilated, and has a smoke detector. If you store your battery indoors, do not store it in a bedroom or any place blocking egress from the area.
- The battery is on a clean, dry and flat, non-flammable surface, preferably metal, ceramic or glass.
- The battery and the charge port connectors (terminals or pins) are dry, clean and free of debris.
- The battery and charger have no items covering or placed on top of them.
- The battery is not exposed to flammable materials or an open flame.
- The ambient temperature around the battery and charger is in the charging temperature range specified by the manufacturer.

CAUTION: During storage, do not expose the battery to heat sources that can result in exceeding the manufacturer's recommended upper temperature limit and result in damage to the battery. For example:

- Direct sunlight
- A hot car in the summer
- Proximity to space heaters or other heat sources



WARNING: Avoid exposing your e-bike to conditions that can result in a short circuit:

- If possible, do not store your e-bike outdoors. Exposure to the elements can quickly deteriorate the e-bike and its components.
- Do not store your e-bike under a cover as this can trap moisture. Condensation can result in corrosion and damage to the battery terminals or other components.
- Unplug the charger from the electrical outlet and the battery before storing the battery. Do not leave a battery connected to the charger after charging or while in storage.
- Do not store your e-bike or battery near any strong magnetic sources.

A short circuit may lead to a thermal runaway, sudden and severe fire or explosion, resulting in serious personal injury, death or property damage.

C. Transporting Your E-bike and Battery

Lithium-Ion batteries are classified and regulated by transportation authorities as “Dangerous Goods” because of the inherent risk of a fire if they are damaged during transport. Check your local laws for details about shipping and transporting an e-bike battery.



WARNING: Do not ship or transport a damaged battery or attempt to circumvent laws regarding shipping of Lithium-Ion batteries. Failure to heed this warning may lead to a fire during the transportation process, resulting in serious personal injury or death to transportation workers or the public, and damage to vehicles or transportation facilities for which you may be held civilly and criminally responsible.

Pay attention to the additional weight of an e-bike when carrying, transporting, pushing, lifting, maneuvering or parking your e-bike.



WARNING: E-bikes can be heavy and awkward to move. Failure to use proper lifting techniques may result in personal injury, or damage to the e-bike if it is dropped.

1. Transporting on a car rack

Transporting an e-bike inside a vehicle (if there’s space in the vehicle to do so safely) is preferable to transporting on an exterior bike rack.

Depending on the type, an e-bike can be significantly heavier than a regular bicycle. Make sure the vehicle-mounted rack is rated for transporting e-bikes and can accommodate the tire width. Pay particular attention when lifting it onto a vehicle-mounted bike rack. Use proper lifting techniques. Lifting the e-bike may require assistance, especially if the rack is on the roof of a car.

If the e-bike is being transported on a roof rack, be aware that your vehicle’s clearance is affected and the e-bike can come in contact with low-hanging

obstacles like garage doors or building entrances. Measure the height of the e-bike on the roof and take note of the clearance measurement.

If the battery and display are easily removable, remove them and place them securely inside the vehicle. This not only keeps your battery safer, it also reduces the weight of the e-bike, which makes it easier to lift and reduces the load on the bike rack.

Make sure the battery can't roll around and is not exposed to direct sunlight or excessive heat or cold for an extended period of time, and the connectors are protected or covered.

Do not use a rack that places the e-bike upside down during transport. Placing the e-bike upside down can result in damage to the handlebar controls. Regularly check that the e-bike is securely held in place by the rack. An e-bike that comes off the rack while driving can be a significant danger to other drivers. It is not recommended to transport your e-bike on a rack that will result in significant exposure to rain without the use of a rain cover. This can lead to water ingress, which can cause damage to electrical components.

2. Transporting on public transit

Familiarize yourself with any relevant rules regarding transporting your e-bike on public transit, such as weight, battery restrictions and tire widths. Some public transit options require that a space is booked; others specify off-peak hours or the need to cover the e-bike.

3. Transporting on an airplane

Lithium-Ion batteries are classified as "Dangerous Goods" for transportation purposes and there are significant restrictions and regulations related to transporting a large Lithium-Ion battery by airplane. Check with your airline for any information about transporting a battery on an airplane before traveling. The battery may need to be shipped separately by a shipper who is trained and authorized to ship Dangerous Goods.

4. Shipping a battery

Lithium-Ion batteries are classified and regulated by transportation authorities as "Dangerous Goods" because of the inherent risk of a fire if they are damaged during transport. Check your local laws for details about shipping and transporting an e-bike battery. Many bicycle retailers are trained in the proper methods for shipping e-bikes and batteries. Please consult your local retailer if you need to ship your e-bike.

 **WARNING: Do not ship or transport a damaged battery or attempt to circumvent laws regarding shipping of Lithium-Ion batteries. Failure to follow this warning may lead to a fire during the transportation process, resulting in serious personal injury or death to transportation workers or the public, and damage to vehicles or transportation facilities for which you may be held civilly and criminally responsible.**

5. Disposing of your battery (end-of-life)

Lithium-Ion batteries are very efficient at conveniently storing large amounts of energy. However, they do not last forever. Batteries are exhaustible items with a lifespan which is subject to use and conditions. Over time and with each charge

and discharge cycle, their capacity to store energy gradually decreases.

Proper use and care can optimize the capacity and extend the life of the battery. Improper care and maintenance can decrease its lifespan and void the warranty. A battery that exhibits signs of significant reduction in runtime has reached the end of its life cycle and should be recycled/replaced. Please refer to the manufacturer's battery specifications for information regarding the number of charge/discharge cycles a battery is expected to provide.

Generally, when a battery's capacity drops below the percentage of capacity specified by your manufacturer, it has reached the end of its useful life cycle and will need to be replaced, as capacity will drop more rapidly after that. If you notice you're no longer getting the range you expect, contact your authorized retailer to have the battery inspected and replaced if necessary.

If your battery's lifespan is diminished to the point of needing replacement, only replace the battery with an original equipment (OE) e-bike battery from your e-bike manufacturer. Do not attempt to have your original battery "refurbished", or replaced with a reconditioned or an unauthorized/third-party battery.

 **WARNING: Do not dispose of an e-bike battery or any other Lithium-Ion battery in your regular household trash or a public trash receptacle. Batteries that enter the regular waste stream can be damaged, leading to a fire resulting in serious personal injury, death, property damage and environmental contamination.**

Dispose of all batteries and chargers that have reached their end of life in an environmentally conscious manner, in accordance with regulations in effect in your country, state or region.

Please contact your e-bike retailer or manufacturer for additional information about battery and charger disposal and recycling, as well as any recycling programs available to you. For example, in the United States Call2Recycle has partnered with a network of manufacturers and retailers to offer a national battery recycling program.

EUROPE: According to EU law, directives 2012/19/EU and 2006/66/EC, all waste electrical and electronic equipment (WEEE) must be collected separately from general waste. Please contact your local e-bike retailer for information on properly disposing of e-bike batteries and chargers.

7. Safely Operating Your E-bike

 **WARNING: Failure to read, understand and follow all instructions and warnings regarding the safe operation of an e-bike may lead to a crash resulting in serious personal injury or death.**

A. Safety First

1. Always wear an approved helmet when riding your e-bike, and follow the helmet manufacturer's instructions for fit, use and care.
2. Do you have all the other required and recommended safety equipment? Refer to **Page 33, Section 7: "Safely Operating Your E-bike", subsection K: "Extreme, Stunt or Competition Riding"**.
3. Do you know where you can legally operate your e-Bike? Refer to **Page 10, Section 5: "E-bike Features and Functions", subsection D: "Where Can I Ride My E-bike?"** It's your responsibility to familiarize yourself with the laws of the areas where you ride, and to comply with all applicable laws regarding safe operation of an e-bike.
4. Do you know how to correctly secure your front and rear wheels? Refer to **Page 48, Section 11: "Tech", subsection A: "Wheels"** to make sure. Riding with an improperly secured wheel can cause the wheel to wobble or disengage from the e-bike, and cause serious injury or death.
5. If your e-bike has toeclips and straps or clipless ("step-in") pedals, make sure you know how they work. Refer to **Page 61, Section 11: "Tech", subsection E: "Pedals"**. These pedals require special techniques and skills. Follow the pedal manufacturer's instructions for use, adjustment and care.
6. Do you have "toe overlap"? On smaller-framed e-bikes your foot may be able to contact the front wheel when a pedal is all the way forward and the wheel is turned. Refer to **Page 61, Section 11: "Tech", subsection E: "Pedals"** to check whether you have toe overlap.
7. Does your e-bike have suspension? If so, refer to **Page 62, Section 11: "Tech", subsection F: "Bicycle Suspension"**. Suspension can change the way an e-bike performs. Follow the suspension manufacturer's instructions for use, adjustment and care.

B. Mechanical Safety Check

Routinely check the condition of your e-bike before every ride.

- **Nuts, bolts screws and other fasteners:** Because manufacturers use a wide variety of fastener sizes and shapes made in a variety of materials, often differing by model and component, the correct tightening force or torque cannot be generalized. To make sure that the many fasteners on your e-bike are correctly tightened, refer to the Fastener Torque Specifications in Appendix C of this manual or to the torque specifications in the instructions provided by the manufacturer of the component in question. Correctly tightening a fastener requires a calibrated torque wrench. A professional e-bike mechanic with a torque wrench should torque the fasteners on your e-bike. If you choose to work on your own e-bike, you must use a torque wrench and the correct tightening torque specifications from the e-bike or component manufacturer or from your authorized retailer. If you need to make an adjustment at home or in the field, we urge you to exercise care, and to have the fasteners you worked

on checked by your authorized retailer as soon as possible.

NOTE: *There are some components, for example the drive system, battery and connecting wiring, that require special tools and knowledge, which you should not attempt to work on yourself. Refer to **Page 43, Section 10: “Fit”** and **Page 48, Section 11: “Tech”** for the items that you may be able to adjust yourself. All other adjustments and repairs should be done by a qualified e-bike mechanic.*

 **WARNING: Correct tightening force on fasteners — nuts, bolts and screws — on your e-bike is important. Too little force, and the fastener may not hold securely. Too much force, and the fastener can strip threads, stretch, deform or break. Either way, incorrect tightening force can result in component failure, which can cause you to lose control and fall.**

- **Make sure nothing is loose.** Lift the front wheel off the ground by two or three inches, then let it bounce on the ground. Anything sound, feel or look loose? Do a visual and tactile inspection of the whole e-bike. Any loose parts or accessories? If so, secure them. If you're not sure, ask someone with experience to check.
- **Tires and Wheels:** Make sure tires are correctly inflated. Check by putting one hand on the saddle, one on the intersection of the handlebars and stem, then bouncing your weight on the e-bike while looking at tire deflection. Compare what you see with how it looks when you know the tires are correctly inflated and adjust if necessary. Refer to **Page 63, Section 11: “Tech”, subsection G: “Tires and Tubes”**.
- **Tires in good shape?** Spin each wheel slowly and look for cuts in the tread and sidewall. Replace damaged tires before riding the e-bike.
- **Wheels true?** Spin each wheel and check for brake clearance and side-to-side wobble. If a wheel wobbles side to side even slightly, or rubs against or hits the brake pads, take the e-bike to an authorized retailer to have the wheel trued.

 **CAUTION: Wheels must be true for rim brakes to work effectively. Wheel truing is a skill that requires special tools and experience. Do not attempt to true a wheel unless you have the knowledge, experience and tools needed to do the job correctly.**

- **Wheel rims clean and undamaged?** Make sure the rims are clean and undamaged at the tire bead and, if you have rim brakes, along the braking surface. A worn braking surface can mean your wheel rim needs to be replaced. Some wheel rims have a rim wear indicator that either becomes visible or disappears as the rim's braking surface wears. Ask your authorized retailer about rim wear and whether your bicycle has a wear indicator. Riding a wheel that is worn out and at the end of its usable life can result in wheel failure, which can cause you to lose control and fall.

 **WARNING: Bicycle wheel rims are subject to wear. Riding a wheel that is at the end of its usable life can result in wheel failure, which can cause you to lose control and fall.**

- **Brakes:** Check the brakes for proper operation. Squeeze the brake levers. Are the brake quick-releases closed? Are all control cables seated and

securely engaged? If you have rim brakes, do the brake pads contact the wheel rim squarely and make full contact with the rim? Do the brakes begin to engage within an inch of brake lever movement? Can you apply full braking force at the levers without having them touch the handlebar? If not, your brakes need adjustment. Do not ride the e-bike until the brakes are properly adjusted by a professional e-bike mechanic. Refer to **Page 57, Section 11: “Tech”, subsection C: “Brakes”**.

- **Wheel retention system:** Make sure the front and rear wheels are correctly secured. Refer to **Page 48, Section 11: “Tech”, subsection A: “Wheels”**.
- **Seat post:** If your seat post has an over-center cam-action fastener for easy height adjustment, check that it is properly adjusted and in the locked position. Refer to **Page 56, Section 11: “Tech”, subsection B: “Seat Post Cam-Action Clamp”**.
- **Handlebar and saddle alignment:** Make sure the saddle and handlebar stem are parallel to the e-bike’s center line and clamped tightly enough so that you can’t twist them out of alignment. Refer to **Section 10: “Fit”, subsection B: “Saddle Position” on Page 44 and subsection C: “Handlebar Height and Angle” on Page 46**.
- **Handlebar grips:** Make sure the handlebar grips are secure and in good condition. If your grips are loose, or have cuts, tears or worn-out areas, have your authorized retailer replace them.
- **Handlebar ends:** Make sure the ends of the handlebar and any extensions are plugged. If not, have your authorized retailer plug them before you ride. If the handlebars have bar end extensions, make sure they are clamped according to the handlebar and extension manufacturer’s instructions. Make sure your handlebar, extensions, grips and brake and shifting controls are secure and allow the safe operation of your e-bike, including the ability to steer, brake and shift without any interference.



WARNING: Loose or damaged handlebar grips or unsecured handlebar extensions can cause you to lose control, causing a crash resulting in serious injury or death.



WARNING: The ends of handlebars and handlebar extensions must be plugged at all times. Unplugged handlebars or extensions can cut or impale you even in a minor crash, resulting in serious injury or death.

Some handlebars are equipped with grips that lock on with a mechanical connection. They must have adequate space to properly align the grips with the handlebar ends and be properly plugged so no portion of the handlebar end is exposed. Locking grips must be properly tightened to avoid movement.



WARNING: Improperly secured locking grips could lead to a loss of control or a crash, resulting in serious injury or death.

VERY IMPORTANT SAFETY NOTE:

Please also read and become thoroughly familiar with the important information on the lifespan of your e-bike and its components in Appendix B on Page 73.

C. Before Your First Ride

When riding an e-bike for the first time, be sure to familiarize yourself with the features and functions of your e-bike by reading all product documentation and reviewing the features with your authorized retailer. It is recommended that you practice accelerating, riding and braking in an area away from people and cars/traffic. Check the handling and response of the e-bike; and check the comfort. If you have any questions, or if you feel anything about the e-bike is not as it should be, consult your authorized retailer before you ride again.

The following questions will help you get to know the functionality and intricacies of operating your e-bike:

- **Brakes:** Familiarize yourself with the types of brakes and braking action of your e-bike. Refer to **Page 57, Section 11: “Tech”, subsection C: “Brakes”** for more information on brakes and braking. Which lever operates the front brake? In some countries, the left lever operates the front brake, but in other countries it’s the opposite. Test the brakes at slow speeds by shifting your weight slightly toward the back while gently applying the brakes, rear brake first. Sudden or excessive application of the front brake could pitch you over the handlebars. Applying brakes too hard can lock up a wheel, which could cause you to lose control and fall. Skidding is an example of what can happen when a wheel locks up.
- **Disc brakes:** Disc brakes are very common on most e-bikes, and they provide significantly more stopping power than other types of brakes.
- **Disc brake rotors:** Braking performance relies upon a clean rotor. It is not recommended to touch the disc brake rotors, as this can transfer oils from the hands to the braking surface and the brake pads. Only touch the rotor when it’s cool, not moving, and with gloves on.

 **WARNING: Applying excessive force too hard or too suddenly to the front brake to slow down or stop can result in loss of control, including causing the rider to pitch over the handlebars, which can result in serious personal injury or death.**

 **WARNING: Properly functioning brakes are essential to the safe operation of your e-bike. If your brakes do not seem to work properly, lose braking power, squeal excessively, or show any signs of damage to the brake levers, cables, housing, calipers, pads or rotors, stop using your e-bike and bring it to your bicycle retailer for inspection and any required repairs. Riding an e-bike with improperly functioning brakes can lead to a crash resulting in serious personal injury or death.**

 **WARNING: Be sure to carefully familiarize yourself with the stopping power of your brakes. If you are new to disc brakes, practice using the front and rear brakes together in a safe place away from traffic until you can safely stop your e-bike in a controlled way. Failure to use disc brakes properly, locking up your wheels or excessive use of the front disc brake can lead to a crash or pitchover, resulting in serious personal injury or death.**

 **WARNING: Disc brakes are equipped with rotors that can generate a lot of heat. Avoid touching any part of the brake system with exposed skin (e.g., hands or legs). Skin contact against a hot brake rotor can result in burns.**



WARNING: Disc brakes are equipped with rotors that can be very sharp. Avoid touching the rotors, especially when the wheels are rotating. Contact with a sharp rotor can cause serious injury.

- **Gears:** Which shifter button goes into a harder or easier gear? Practice shifting the gears. Remember to never move the shifter while pedaling backward, nor pedal backwards immediately after having moved the shifter. This could jam the chain and cause serious damage to the e-bike. Refer to **Page 59, section 11: “Tech”, subsection D: “Shifting Gears”**.
- **Pedals:** If your e-bike has clipless pedals or toeclips, practice getting in and out of the pedals. Refer to **Page 61, Section 11: “Tech”, subsection E: “Pedals”**.
- **Suspension:** If your e-bike has suspension, familiarize yourself with how the suspension responds to brake application and rider weight shifts. Refer to **Page 62, Section 11: “Tech”, subsection F: “Bicycle Suspension”**.
- **Display:** What are the features and functions? Which buttons change the power mode?
- **Lights:** Does the light turn on when the e-bike is powered on, or is it turned on separately? Make sure the light is always on. The front light beam must be angled properly so it doesn't blind oncoming traffic.
- **Power:** Are you familiar with your e-bike's power output? Start getting to know your e-bike in the lower assistance settings, gradually work up to the higher settings. Once comfortable, start riding under normal traffic conditions.
- **Walk-assist:** Are you familiar with the function of the power-assist mode? Test the walk-assist function to familiarize yourself with walking next to an e-bike that's moving with low speed.
- **Battery:** Can the battery be easily removed from the e-bike? If so, be sure to familiarize yourself with the process to properly and safely remove and install the battery.
- **Starting a ride:** Do you know how to safely start a ride on an e-bike? Develop a proper habit for starting your ride. Make sure the power is off and you're properly seated on the saddle, with hands on the handlebar and one or more brakes engaged before putting a foot on a pedal.



WARNING: Do not put a foot on a pedal and swing a leg over the e-bike. This is especially important if the power is on. While this technique may work fine on a regular bicycle, this is potentially dangerous to do on an e-bike, as it can cause the e-bike to unexpectedly launch once pressure is applied to a pedal, leading to a crash resulting in serious personal injury.

D. Before Every Ride

Before every ride, you need to make sure your e-bike is in proper working order. Here are some questions to ask yourself before every ride:

- Are all battery and terminal connections (control unit, command console, drive unit) plugged properly?
- Is the battery fully charged? Charge it after each ride. Don't wait until it's fully discharged. A battery in a state of deep discharge can negatively affect the ability to charge it, and can also reduce its charge capacity.
- Is the display functioning properly? Any error messages? Don't ride if it's

showing errors or improper information.

- Is the battery tightly installed and securely locked (if it has a lock)?
- Is your light turned on, functioning and angled properly? If a bulb is dead, only replace it with a compatible light bulb.
- Are the tires in good condition and properly inflated? If you have questions about the proper tire pressure for your e-bike, check the inflation range printed on the tire sidewall, or talk to your e-bike retailer. Refer to **Page 63, Section 11: “Tech”, subsection G: “Tires and Tubes”** for additional information about tire inflation.
- Are the brakes working properly? Squeeze both brake levers firmly to make sure the brakes are working and able to slow and stop the e-bike.

NOTE: Some brake systems have a cutoff switch to stop the motor when the brakes are applied. Check your model-specific e-bike manual to determine if your e-bike has this feature. If so, check the function of the cutoff switch before each ride.

E. General E-bike Safety

 **WARNING: Failure to read, understand and follow all instructions and warnings regarding the safe operation of an e-bike may lead to a crash resulting in serious personal injury or death.**

The addition of an integrated drive system means in some ways your e-bike is like a regular bicycle, but in other ways it's different and unique. The higher the class and top speed, the more important these safety notices become. These differences mean you must read and follow all instructions in this Manual and any manufacturer product documentation. You should not treat your e-bike the same as a regular bicycle. The content in this Manual related to rider safety applies to all e-bikes, regardless of type or class.

Factors to pay attention to when riding an e-bike:

- **Power:** The added power and weight of the drive system means an e-bike may be faster and heavier than a regular bicycle. This additional acceleration, speed and weight can dramatically affect the handling, cornering and braking of your e-bike. The faster you go and the more weight you carry (including passengers or cargo), the more you have to exercise caution when navigating around traffic and other people, slowing down (preparing for greater stopping distances), and cornering (slowing down well before entering the corner).
- **Cargo weight:** When transporting cargo or passengers, pay particular attention to the handling and braking characteristics when riding the e-bike with the additional load. Carrying additional weight can alter the center of gravity of the e-bike, which can negatively affect the rate of acceleration, braking distances and safe cornering. There is an increased risk of a crash resulting in the rider or passenger going over the bars or falling off the e-bike.

 **WARNING: Failure to take into account the additional weight and speed of an e-bike and its cargo can lead to a crash resulting in serious personal injury or death.**

- **Helmet use (fig. 5):** Always wear a properly fitted helmet that is certified as meeting safety regulations when riding your e-bike. Some manufacturers may offer helmets that are specifically designed for use with e-bikes.



fig. 5



WARNING: Wearing a helmet has been shown to reduce the frequency and severity of injury should there be a crash. Failure to wear a helmet may increase the risk of serious personal injury or death.

- **Display(s):** If your e-bike has a display on the handlebar or frame, avoid paying excessive attention to it. Spending extended periods of time looking at your display can be distracting and can result in a crash. It's intended only for occasional glances. Be sure to keep your attention on the road ahead.
- **Children and pets:** When riding an e-bike in proximity of children or animals, always be aware of their location and exercise caution to reduce the risk of injury.
- **Hot surfaces:** Certain components on an e-bike can be hot to the touch during or immediately after a ride.



WARNING: Components can reach very high temperatures during use, especially when the e-bike is subjected to high loads at low speeds, resulting in poor air movement around the e-bike. For example, riding up a long, sustained hill, riding with a heavy load, or riding down a long hill with prolonged brake application, can result in one or more systems generating significant heat. Avoid touching any part of the battery housing, drive system or brake system with exposed skin (e.g., hands or legs). Contact with hot components can result in burns if touched.

- **Sun exposure:** Do not park for extended periods in the blazing sun. Prolonged exposure to excessive heat and UV rays from the sun can result in damage to the battery and other components. It can also cause paint to fade, and rubber or plastic parts to dry out, become brittle and crack.
- **Component temperature:** There are numerous circumstances that can affect component temperatures. The more you pay attention to the circumstances and try to mitigate the effects, the lower the temperatures may be. The examples below describe circumstances that generally require more effort from components like the motor, battery and brakes, which can cause them to generate more heat.

- High ambient temperature
- Hilly terrain (elevation gain)
- Long distance of ride
- Low level of assistance
- High rider energy output
- High combined weight of e-bike, rider and cargo
- Inefficient gear selections
- Sustained application of brakes



WARNING: An e-bike may apply greater loads to your tires during use than a regular bicycle. If you replace the tires on your e-bike, it is

strongly recommended to only use tires intended for e-bikes. Worn or incorrect tires can result in loss of control when cornering or braking which can cause a crash resulting in serious personal injury or death.

 **WARNING:** Keep medical devices/implants (e.g., a pacemaker), or sensitive electronic devices that retain electronic/digital data away from any magnets or sensors located on your e-bike, which may interfere with the function of these devices.

F. Lighting and Night Riding

Riding an e-bike at night is much more dangerous than riding during the day. A bicyclist is very difficult for motorists and pedestrians to see. Therefore, children should never ride at dawn, at dusk or at night. Adults who choose to accept the greatly increased risk of riding at dawn, at dusk or at night need to take extra care both riding and choosing specialized equipment that helps reduce that risk. Consult your authorized retailer about night riding safety equipment.

Having a headlight on while riding increases your visibility, even in the daytime. Many e-bikes are equipped with a headlight that is connected to and powered by the drive system, when the battery is charged and the system is turned on. If your e-bike is equipped with a headlight, it is recommended to always have it on while riding. If your headlight does not turn on automatically when the drive system is turned on, turn on the headlight.

NOTE: Light systems connected to the drive system won't work if the battery is removed or fully discharged. In some countries, if the e-bike is ridden without lights, it won't be in compliance with traffic laws.

 **WARNING:** Using a headlight and taillight is highly recommended. Riding an e-bike at night or in low light or visibility conditions without a functioning headlight and taillight can create an increased risk of impact with obstacles, unseen road conditions, pedestrians, animals or other road users, including motor vehicles, leading to a crash resulting in serious personal injury or death.

 **WARNING:** Reflectors are not a substitute for required lights. Riding at dawn, at dusk, at night or at other times of poor visibility without an adequate bicycle lighting system and without reflectors is dangerous and may result in serious injury or death.

Bicycle reflectors are designed to pick up and reflect car lights and street lights in a way that may help you to be seen and recognized as a moving bicyclist.

 **CAUTION:** Check reflectors and their mounting brackets regularly to make sure that they are clean, straight, unbroken and securely mounted. Have your authorized retailer replace damaged reflectors and straighten or tighten any that are bent or loose.

The mounting brackets of front and rear reflectors are often designed as brake straddle cable safety catches which prevent the straddle cable from catching on the tire tread if the cable jumps out of its yoke or breaks.

 **WARNING:** Do not remove the front or rear reflectors or reflector brackets from your e-bike. They are an integral part of the e-bike's safety system. Removing the reflectors reduces your visibility to others using the roadway. Being struck by other vehicles may result in serious injury or death.

 **WARNING:** The reflector brackets may protect you from a brake straddle cable catching on the tire in the event of brake cable failure. If a brake straddle cable catches on the tire, it can cause the wheel to stop suddenly, causing you to lose control and fall.

If you choose to ride under conditions of poor visibility, check and be sure you comply with all local laws about night riding, and take the following strongly recommended additional precautions:

- Purchase and install battery- or generator-powered head and tail lights which meet all regulatory requirements for where you live and provide adequate visibility.
- Wear light-colored, reflective clothing and accessories, such as a reflective vest, reflective arm and leg bands, reflective stripes on your helmet, flashing lights attached to your body and/or your e-bike. Any reflective device or light source that moves will help you get the attention of approaching motorists, pedestrians and other traffic.
- Make sure your clothing or anything you may be carrying on the e-bike does not obstruct a reflector or light.
- Make sure that your e-bike is equipped with correctly positioned and securely mounted reflectors.

While riding at dawn, at dusk or at night:

- Ride slowly.
- Avoid dark areas and areas of heavy or fast-moving traffic.
- Avoid road hazards.
- If possible, ride on familiar routes.

If riding in traffic:

- Be predictable. Ride so that drivers can see you and predict your movements.
- Be alert. Ride defensively and expect the unexpected.
- If you plan to ride in traffic often, ask your authorized retailer about traffic safety classes or a good book on bicycle traffic safety.

G. General Bicycle Safety

1. All of the same safe riding practices that apply to unpowered bicycles also apply to e-bikes, with the important difference being the addition of motor power that can propel you and your e-bike at greater speeds and allow you to accelerate more quickly. This makes your adherence to these general rules of safety that much more important.
2. Always do the Mechanical Safety Check. Refer to **Page 22, Section 7: "Safely Operating Your E-bike", subsection B: "Mechanical Safety Check"** before you get on an e-bike.
3. Be thoroughly familiar with the controls of your e-bike. Refer to **Section 11: "Tech", subsections C: "Brakes" on Page 57, D: "Shifting Gears" on Page 59 and E: "Pedal" on Page 61.**
4. Be careful to keep body parts and other objects away from the sharp teeth

of chainrings, the moving chain, the turning pedals and cranks, and the spinning wheels of your e-bike.

5. Always wear:
 - Shoes that will stay on your feet and will grip the pedals. Make sure that shoelaces cannot get into moving parts, and never ride barefoot or in sandals.
 - Bright, visible clothing that is not so loose that it can be tangled in the e-bike or snagged by objects at the side of the road or trail.
 - Protective eyewear, to protect against airborne dirt, dust and bugs — tinted when the sun is bright, clear when it's not.
6. Unless your e-bike was specifically designed for jumping (See Appendix A, Intended Use) don't jump with your e-bike. Jumping an e-bike, particularly a mountain e-bike, can be fun; but it can put huge and unpredictable stress on the e-bike and its components. Riders who insist on jumping their e-bikes risk serious damage, to their e-bikes as well as to themselves. Before you attempt to jump, do stunt riding or race with your e-bike, read and understand **Page 33, Section 7: "Safely Operating Your E-bike", subsection K: "Extreme, Stunt or Competition Riding"**.
7. Ride at a speed appropriate for conditions. Higher speed means higher risk.

H. Riding Safety

1. Obey all Rules of the Road and all local traffic laws.
2. You are sharing the road or the path with others — motorists, pedestrians and other cyclists. Respect their rights.
3. Ride defensively. Always assume that others do not see you.
4. Look ahead, and be ready to avoid:
 - Vehicles slowing or turning, entering the road or your lane ahead of you, or coming up behind you.
 - Parked car doors opening.
 - Pedestrians stepping out.
 - Children or pets playing near the road.
 - Pot holes, sewer grating, railroad tracks, expansion joints, road or sidewalk construction, debris and other obstructions that could cause you to swerve into traffic, catch your wheel or cause you to crash.
 - The many other hazards and distractions which can occur on an e-bike ride.
5. Ride in designated bike lanes, on designated bike paths or as close to the edge of the road as practicable, in the direction of traffic flow or as directed by local governing laws.
6. Stop at stop signs and traffic lights; slow down and look both ways at street intersections. Remember that an e-bike always loses in a collision with a motor vehicle, so be prepared to yield even if you have the right of way.
7. Use approved hand signals for turning and stopping.
8. Never ride with headphones or earbuds. They mask traffic sounds and emergency vehicle sirens, distract you from concentrating on what's going on around you, and their wires can tangle in the moving parts of the e-bike, causing you to lose control.
9. Never carry a passenger, unless the e-bike was designed to carry a passenger. Before installing a child carrier or trailer, check with your authorized retailer or the e-bike manufacturer to make sure the e-bike is designed for it. If the e-bike is suitable for a child carrier or trailer, make sure that the carrier or trailer is correctly mounted and the child is secured

- and wearing an approved helmet. Refer to **Page 37, Section 8:** “Best Practices for Riding and Carrying Passengers and Cargo” for more information on carrying passengers, child carriers and trailers.
10. Never carry anything which obstructs your vision or your complete control of the e-bike, or which could become entangled in the moving parts of the e-bike.
 11. Never hitch a ride by holding on to another vehicle.
 12. Don't do stunts, wheelies or jumps. If you intend to do stunts, wheelies, jumps or go racing with your e-bike despite advice to the contrary, refer to **Page 33, Section 7:** “Safely Operating Your E-bike”, **subsection K:** “Extreme, Stunt or Competition Riding”, now. Think carefully about your skills before deciding to take the large risks that go with this kind of riding.
 13. Don't weave through traffic or make any moves that may surprise people with whom you are sharing the road.
 14. Observe and yield the right of way.
 15. Never ride your e-bike while under the influence of alcohol or drugs.
 16. If possible, avoid riding in bad weather, when visibility is obscured, at dawn, dusk or in the dark, or when extremely tired. Each of these conditions increases the risk of a crash.

I. Off-Road Safety

We recommend that children not ride on rough terrain unless they are accompanied by an adult. Some e-bikes may be designed for off-road use. If your e-bike is designed for off-road use and you choose to ride your e-bike off-road, follow these best practices:

1. The variable conditions and hazards of off-road riding require close attention and specific skills. Start slowly on easier terrain and build up your skills. If your e-bike has suspension, the increased speed you may develop also increases your risk of losing control and falling. Get to know how to handle your e-bike safely before trying increased speed or more difficult terrain.
2. Wear safety gear appropriate to the kind of riding you plan to do.
3. Don't ride alone in remote areas. Even when riding with others, make sure that someone knows where you're going and when you expect to be back.
4. Always take along some kind of identification, so that people know who you are in case of a crash; and take along some cash for food, a cool drink or an emergency phone call.
5. Yield right of way to pedestrians and animals. Ride in a way that does not frighten or endanger them, and give them enough room so that their unexpected moves don't endanger you.
6. Be prepared. If something goes wrong while you're riding off-road, help may not be close.
7. Before you attempt to jump, do stunt riding or race with your e-bike, read and understand **Page 33, Section 7:** “Safely Operating Your E-bike”, **subsection K:** “Extreme, Stunt or Competition Riding”.

J. Wet-Weather Riding

 **WARNING: Wet weather impairs traction, braking and visibility, both for the bicyclist and for other vehicles sharing the road. The risk of a crash is dramatically increased in wet conditions.**

Under wet conditions, the stopping power of your brakes (as well as the brakes of other vehicles sharing the road) is dramatically reduced and your tires don't grip nearly as well. This makes it harder to control speed and easier to lose control. To make sure that you can slow down and stop safely in wet conditions, ride more slowly and apply your brakes earlier and more gradually than you would under normal, dry conditions. Refer to **Page 32, Section 7: "Safely Operating Your E-bike", subsection J: "Wet-Weather Riding"**.

K. Extreme, Stunt or Competition Riding

Whether you call it *Aggro, Hucking, Freeride, North Shore, Downhill, Jumping, Stunt Riding, Racing, Enduro* or something else: if you engage in this sort of extreme, aggressive riding, you voluntarily assume a greatly increased risk of injury or death.

Not all e-bikes are designed for these types of riding, and those that are may not be suitable for all types of aggressive riding. Check with your authorized retailer or the e-bike's manufacturer about the suitability of your e-bike before engaging in extreme riding.

When riding fast down hill, you can reach speeds achieved by motorcycles, and therefore face similar hazards and risks. Have your e-bike and equipment carefully inspected by a qualified mechanic and be sure it is in perfect condition. Consult with expert riders, area site personnel and race officials on conditions and equipment advisable at the site where you plan to ride. Wear appropriate safety gear, including an approved full-face helmet, full-finger gloves, and body armor. Ultimately, it is your responsibility to have proper equipment and to be familiar with course conditions.

 **WARNING: Although many catalogs, advertisements and articles about bicycling depict riders engaged in extreme riding, this activity is extremely dangerous, increases your risk of injury or death, and increases the severity of any injury. Remember that the action depicted is being performed by professionals with many years of training and experience. Know your limits and always wear a helmet and other appropriate safety gear. Even with state-of-the-art protective safety gear, you could be seriously injured or killed when jumping, stunt riding, riding downhill at speed or in competition.**

 **WARNING: E-bikes and bicycle parts have limitations with regard to strength and integrity, and this type of riding can exceed those limitations or dramatically reduce the length of their safe use.**

We recommend against this type of riding because of the increased risks; but if you choose to take the risk, at least:

- Take lessons from a competent instructor first.
- Start with easy learning exercises and slowly develop your skills before trying more difficult or dangerous riding.
- Use only designated areas for stunts, jumping, racing or fast downhill riding
- Wear a full-face helmet, safety pads and other safety gear.
- Understand and recognize that the stresses imposed on your e-bike by this kind of activity may break or damage parts of the e-bike and void the warranty.

- Take your e-bike to your authorized retailer if anything breaks or bends. Do not ride your e-bike when any part is damaged.
- If you ride downhill at speed, do stunt riding or ride in competition, know the limits of your skill and experience. Ultimately, avoiding injury is your responsibility.

L. Changing Components or Adding Accessories

There are many components and accessories available to enhance the comfort, performance and appearance of your e-bike. However, if you change components or add accessories, you do so at your own risk. The e-bike's manufacturer may not have tested that component or accessory for compatibility, reliability or safety on your e-bike. Before installing any component or accessory, including but not limited to a different size tire, a lighting system, a luggage rack, a child seat or a trailer, make sure that it is compatible with your e-bike by checking with your authorized retailer. Be sure to read, understand and follow the instructions that accompany the products you purchase for your e-bike. See also *Appendix A, Page 73 and B, Page 78.*

⚠ WARNING: Failure to confirm compatibility, properly install, operate and maintain any component or accessory can result in serious injury or death.

⚠ WARNING: Exposed springs on the saddle of any e-bike fitted with a child seat can cause serious injury to the child.

⚠ WARNING: Changing the components on your e-bike with other than genuine replacement parts may compromise the safety of your e-bike and may void the warranty. Check with your authorized retailer before changing the components on your e-bike.

⚠ WARNING: Any accessory or component attached to, on or near a rotating wheel poses a risk of contacting or stopping the wheel, leading to a crash resulting in serious injury or death. Before every ride check to ensure that all such accessories and components, and the fasteners used to attach them, are securely mounted to your e-bike.

⚠ WARNING: Any object that unexpectedly and abruptly stops the rotation of the front wheel can cause the e-bike and rider to pitch forward (fig. 6), which can result in serious injury or death.

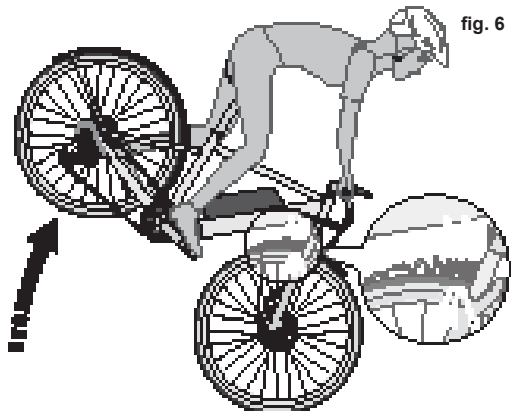

fig. 6

M. Walk-assist Mode

Some e-bikes are equipped with a walk-assist mode to help you move the e-bike around without riding it. Proper use of walk-assist mode is important to prevent loss of control and injury.

- Only use when dismounted.
- Keep both hands on the grips and fingers on one or both brake levers so the motor power can be stopped immediately if necessary.
- Keep clear of the pedals while walking the e-bike.



WARNING! Make sure the e-bike system is turned off so that the walk-assist mode cannot be accidentally activated when:

- **Pushing the e-bike without the walk-assist mode turned on.**
- **Transporting the e-bike (lifting onto a car, bike rack or a train).**
- **Carrying the e-bike up and down stairs.**
- **Performing any maintenance or service (e.g., placing the chain on a chainring) or other drivetrain parts, pedals or fixing a flat tire.**

N. Getting the Most Out of Your E-bike

The variety of factors that affect your e-bike's range makes it impossible to accurately estimate the range before a ride. Pay attention to the variables to maximize your range and adjust any factors during the ride as needed (e.g., lower assistance level, optimal gear shifting or lower speeds) to help you reach your destination.

To maximize battery range, turn off the drive system when not in use. Most drive systems have a sleep mode to conserve energy, which will turn off if the e-bike has not been active for a predetermined amount of time.

Your e-bike's range varies based on a number of factors:

- **The level of motor assistance (power mode):** More power assistance from the motor will make riding easier but will use more battery power.
- **How much power you apply to the pedals:** The more power the rider provides, the less the motor has to work.
- **How fast you ride:** The faster you ride, the more power the motor generates, the more energy is required from the battery.
- **Riding habits:** The more efficiently you ride, the greater the range will be. For example, regular starts and stops will reduce your range.
- **Gear choices:** The higher the gear, the more power is required from the motor. Choosing the best gear for the terrain can improve your range.
- **Tire type and air pressure:** Tires with aggressive tread or lower than recommended pressure can increase your rolling resistance and reduce your range.
- **Number of battery charge/discharge cycles:** Regular charging and discharging reduces the battery's capacity, which will reduce your range.
- **Terrain features:** Hilly terrain will reduce your range more than flat terrain.
- **Wind and temperature conditions:** A strong headwind or colder temperatures can reduce the efficiency of your e-bike and reduce your range.
- **Total combined weight (e-bike, rider and cargo):** Carrying heavier cargo makes the motor work harder, which can reduce your range.
- **Condition of e-bike components:** Certain components like wheel

bearings, if not functioning smoothly, can increase rolling resistance, which can reduce your range.

To get the most range:

- Fully charge the battery before each ride.
- Use lower assistance modes.
- Ride more slowly and efficiently.
- Choose the right gear for the terrain and accelerate gently.
- Check tire pressure regularly and set the pressure as recommended by the manufacturer.
- Make sure your e-bike is in proper working order and serviced regularly, the wheels spin freely and brake discs clear the brake pads.
- Carry the least amount of weight necessary.

Choose your gears according to the speed and incline you're riding. Shift gears regularly to keep a consistent, comfortable pedaling speed, or cadence. Riding in a high gear with a low cadence increases the demand on the motor and battery, which can reduce your range. Choosing a lower gear with a higher cadence also puts less strain on the drivetrain, which can increase the longevity of the drivetrain.

Maintain a steady pace and anticipate changes to your surroundings whenever possible. Any unnecessary deceleration requires more energy to accelerate back up to speed, which reduces your available range.

Before coming to a stop, shift gears into an easier gear. This will make accelerating from a stop easier, and require less energy from the battery to get back up to speed.

When riding uphill, keep to a reasonable pace and choose a lower gear with a higher cadence. This puts less strain on the motor, which can help increase the available range.

CAUTION (e-bikes equipped with throttle): Riding uphill at slow speed using only the throttle can result in overheating of the drive system due to excessive strain. This can result in component failure, as well as subject the battery to excessive stress, which can reduce its capacity.

Center-mounted or "mid-drive" motors (motor that applies power to the cranks) share many of the same drivetrain components as a regular bicycle. However, the increase in force applied at the crank from the motor can result in more strain to the drivetrain components (chain, derailleur, cassette, chainrings and derailleur hanger). In order to minimize the strain and maximize the lifespan of the drivetrain, apply best practices when shifting:

- Shift efficiently by anticipating when the shift will be needed beforehand. For example, shifting into an easier gear before starting to climb a hill instead of during the climb.
- Ride with a cadence that matches the terrain and speed, so you're not pedaling too slowly and with too much force.
- When shifting, reduce your pedal force or throttle, shift the gears, then gently re-engage your pedal force once the shift is complete.

 **WARNING: Shifting under a heavy load can cause damage to the drivetrain components, including breaking the chain. This can cause a crash, resulting in serious personal injury or death.**

Keep your e-bike clean, well-maintained and functioning optimally. Check tire pressure regularly. The better your e-bike is maintained, the more efficiently it will operate.

Familiarize yourself with your manufacturer's specific startup recommendations. Before doing more extensive, longer and more demanding rides, become familiar with your e-bike's functions, features and operation so you can adapt your riding style to changing conditions.



WARNING: Conditions on the road, path or trail you are riding on can present sudden hazards. Avoid or exercise caution by slowing your speed on dangerous terrain, including:

- Potholes
- Train tracks
- Wet, oily or icy terrain
- Gravel or sand
- Curbs
- Wet leaves
- Speed bumps
- Drain grates
- Broken glass
- Thorns
- Steep hills
- Sharp or sudden turns
- Other hazards that can cause a puncture and/or loss of control

Failure to take these potentially dangerous conditions into account can cause a crash, leading to serious personal injury or death.

8. Best Practices for Riding and Carrying Passengers and Cargo

When riding your e-bike, you are usually sharing the roadway, path or trail with other users. This presents certain risks to yourself and others.



WARNING: Riding your e-bike on public roads shared with motor vehicles presents an obvious and assumed risk of collision. Most serious injuries and fatalities related to e-bike use are the result of collisions with larger, faster motor vehicles. When on an e-bike, remember that you do not have the protection enjoyed by motorists, such as seat belts, airbags and the surrounding structure of a motor vehicle. As a road user, it is your responsibility to follow the rules of the road and operate your e-bike in such a manner as to reduce your risk of a collision. Failure to follow this warning may lead to a collision or crash, resulting in serious personal injury or death.

Please be considerate of others around you, whether they are motorists, pedestrians or cyclists. Please pay attention to the following factors:

- **Your speed:** Always ride at a speed within your comfort zone and/or according to the conditions you're riding in (e.g., rain, darkness or loose

dirt). This especially applies when riding in wet weather, as you'll need even more time and greater distance to slow down and are more likely to crash. Give lots of room to slow down and apply brakes gently. Riding at speeds beyond your comfort or skill level can result in a serious crash. Even if it's legal, it's not always safe to be riding at high speeds on paths or trails when other users are present.

- **Surrounding speeds:** Consider the speeds of those around you and how your speed is perceived. E-bike speeds are often underestimated since they look like regular bicycles and decisions are made with the assumption you're riding slower than you are. Always be vigilant about what's going on around you at intersections or anyplace where cars might cross your path.
- **Surrounding people:** Exercise caution when passing pedestrians or other cyclists. The greater the speed difference, the greater the likelihood of a crash. Slow when people or pedestrians are present, as they may not be aware of your presence and may step out in front of you. Riding with greater speed and weight requires more care, especially around other riders. Avoid distractions and stay focused on the road ahead. When following other riders, maintain a sufficient enough gap to allow you to stop safely. The higher your speed, the greater the gap should be.



CAUTION: When riding in a group, following other riders, or riding on crowded roads, paths or trails, always maintain a gap sufficient to allow you to stop safely.

- **Applying brakes:** Always be prepared to squeeze the brake levers. Your brakes are designed to take into account the weight of the e-bike, rider and cargo to stop your e-bike. If you apply them in a controlled manner, your e-bike will slow down and come to a stop.
- **Brake power:** Don't exclusively apply the front brake to slow down. This can put undue stress on components and can put too much weight on the front of the e-bike. Instead, to slow the e-bike down safely, gently engage the rear brake, followed by the front brake. The amount of force applied to each brake varies depending on the terrain, weather conditions, speed, rider/cargo weight and trajectory.



WARNING: Applying excessive force to the front brake to slow down can result in loss of control, including causing the rider to pitch over the handlebars, which can result in serious personal injury or death.

A. Riding with Passengers

Check with your authorized retailer or e-bike manufacturer for information about transporting passengers with your e-bike. Many e-bikes are designed for use by one person (the rider) unless explicitly stated by the manufacturer. Any transportation of a passenger beyond the intended design of the e-bike is at your own risk. Certain passenger and cargo e-bikes have requirements for how passengers are placed on the e-bike. Follow any rules and restrictions specified by the e-bike manufacturer.

Before transporting passengers, including children (see "Transporting Youth and Children" below), inform yourself of all applicable laws, requirements and restrictions (including age restrictions) for your particular country or region. Some regions do not allow riding with passengers.

When carrying a passenger behind the rider, since they cannot see what's coming, ride with more caution, anticipate whenever possible what's coming sooner than usual, and always notify the passenger of an upcoming sudden acceleration, deceleration, turn, bump or obstacle that could impact their safety as a passenger, so they can brace for the event.

Remember: It is the rider's responsibility to ensure the safe operation of the e-bike and the safety of their passenger. Whenever possible, plan your route to avoid riding significant hills while carrying passengers.

 **WARNING: Riding with passengers on an e-bike significantly affects the balance, handling, acceleration and braking distance of an e-bike, especially on a significant downhill grade. Additional weight and speed means additional forward momentum that will need to be counteracted by your brakes in order to slow your e-bike or bring it to a stop. Because braking demands increase with additional weight when going downhill, there is a greater need to control your speed at the beginning and during the descent. Riding at speeds that are too high to safely manage can lead to a loss of control or crash, resulting in serious personal injury or death.**

Weight Limits: E-bikes often have maximum stated structural weight limits for rider, passenger and any cargo. Pay particular attention to the structural weight limits specified by your e-bike manufacturer, and do not exceed them. If you are unsure about the weight limit for your e-bike, ask your e-bike retailer or the manufacturer. Even if the rider, passenger and cargo weight are within the structural weight limits, the rider must also determine if they're comfortably and safely able to manage the weight of a passenger.

 **WARNING: Do not exceed the maximum structural weight limit of your e-bike. Exceeding the limit can affect the structural integrity of the e-bike leading to a failure of the e-bike's frame, fork or components, and can also result in unsafe increases in braking distances. Any of these conditions can lead to a crash resulting in serious personal injury or death.**

To protect passengers, always make sure to prevent loose clothing or personal belongings such as purses or backpacks from interfering with moving parts while your e-bike is in motion.

 **WARNING: Any contact from body parts, clothing or cargo with the e-bike while in motion can unexpectedly and abruptly stop the e-bike, leading to a crash resulting in serious personal injury or death.**

 **CAUTION: Make sure the e-bike is secured and stable when loading or unloading passengers. The e-bike can tip over when passengers are being loaded or unloaded, which can result in injury.**

Your e-bike may be equipped with a kickstand. The kickstand is designed to support only the e-bike without rider, cargo or passengers, while on a stable, flat surface. Do not rely on the kickstand to support the e-bike during the loading or unloading process.

Passengers should not get on the e-bike unless the rider is holding the

e-bike. Never allow a child to climb onto the e-bike by themselves, unless an adult is making sure the e-bike is steady.

Some e-bikes may have a seating area, handholds and/or foot supports for the passenger. Passengers should be seated and handholds and foot supports should be used at all times when the e-bike is in motion.

 **WARNING: Passengers must not stand on foot supports while the e-bike is in motion. Standing on the foot supports negatively affects the center of gravity of the e-bike and can cause instability leading to a crash, which can result in serious personal injury or death.**

Carrying Pets: Due to the unpredictable nature of pets, it is not recommended to ride with a pet as a passenger or live cargo. Pets should always be transported in a closed pet carrier or in a trailer designed for that purpose. Transporting a pet that is not restrained or confined puts the rider and pet at significant risk of injury, and you do so at your own risk.

B. Transporting Youth or Children

 **WARNING: Riding with youth or children as passengers on an e-bike carries significant risks. Parents must exercise caution and good judgment, and know they assume all risks when transporting a child.**

 **WARNING: Children must always wear an approved helmet when passengers on e-bikes.**

Age restrictions vary depending on the country or region. Before riding with a child as a passenger, familiarize yourself with and obey all applicable laws, requirements and restrictions for your country or region.

Using a child carrier: Only use child carriers that are approved by the manufacturer for use with your e-bike and that conform to local laws. Refer to the e-bike manufacturer for any additional information about child carriers specific to your e-bike.

 **WARNING: Always follow the installation, safety and compatibility instructions provided by the manufacturer of the child carrier. Ensure the child carrier is properly installed as instructed, with sufficient clearance for the child's heels and safety for fingers, and that the child is within the weight range specified by the manufacturer. Always install foot restraints or guards designed to prevent body parts becoming caught in a revolving wheel. Failure to follow these warnings and all instructions provided by the manufacturer can cause serious injury to the child or a crash, which can result in serious personal injury or death.**

 **WARNING: Do not leave a child unattended in a child carrier, and do not rely on a kickstand to hold an e-bike up safely, except when buckling the child in the child carrier. Always hold the e-bike safely and securely when a child is in the child carrier, and remove the child before leaving the e-bike. An unattended child can wriggle unexpectedly and cause the e-bike to fall over, which can result in serious personal injury or death.**

Check on your child regularly. If they fall asleep, it can put excessive strain on their neck. A child should only be placed in a child seat if they're able to hold their head up independently, as well as withstand the movements and bouncing that come with riding on an e-bike.

 **WARNING: Improper mounting of a child carrier, trailer or accessory may result in failure of the frame, fork or components, causing serious personal injury or death.**

C. Transporting Cargo

 **WARNING: Cargo should only be carried on an e-bike that is designed for that purpose. Carrying cargo on an e-bike that is not designed for that purpose may lead to loss of control or crash, which can result in serious personal injury or death.**

Always load cargo as low as possible to help maintain a low center of gravity. This helps improve the stability of the e-bike.

When riding with cargo, practice and familiarize yourself with the braking distances and handling characteristics of the e-bike by starting with lighter loads and gradually increasing the weight. Carrying increased weight will increase your braking distance, which requires more careful use of your brakes. To help maintain control, start by applying the rear brake first, then gently apply the front brake. Gradually increase the braking force as needed to safely slow the e-bike in a controlled manner.

 **WARNING: Cargo must be properly secured to the e-bike with no loose straps and checked periodically to ensure the cargo remains secure. Loose cargo can shift or fall off the e-bike and can interfere with moving parts. Loose straps can also interfere with moving parts. Either of these situations can cause a crash, resulting in serious personal injury or death.**

 **WARNING: Always make sure the e-bike is stable and secure before loading or unloading any cargo, and the cargo is loaded to minimize any interference with obstacles, other cyclists, pedestrians or motorists. Always be aware of your surroundings. Cargo that interferes with your surroundings can cause a crash, which can result in serious personal injury or death.**

1. Cargo e-bikes

 **WARNING: All of the above instructions and warnings about carrying passengers and cargo apply to cargo e-bikes. Failure to follow these warnings could result in a crash leading to serious personal injury or death.**

Cargo e-bikes are e-bikes designed specifically to carry cargo and/or passengers. The handling characteristics of cargo e-bikes can be very different from a regular e-bike. As cargo e-bikes typically handle much slower, additional practice is often required to get used to the handling. Give more room for turning, anticipate needing more distance to slow down, especially when carrying cargo. Practice parking the cargo e-bike as well. Do not ride with cargo that isn't properly secured. **Please review Appendix C for Xtracycle specific information.**

D. Using a Trailer

If use of a trailer, carrier or other passenger accessory is allowed with your e-bike, make sure the trailer is compatible with your e-bike. Consult your authorized retailer for more information about trailer compatibility and installation. The e-bike must be safe to ride with the trailer accessories installed, and the trailer must be securely attached to the e-bike.

 **WARNING: E-bike manufacturers cannot test all available trailers for compatibility and safety. Always follow the trailer manufacturer's installation, safety and usage instructions. An incompatible or incorrectly installed trailer can cause a crash, which can result in serious personal injury or death.**

Towing a trailer with passengers or cargo increases the weight being towed by the e-bike, which can negatively affect handling in multiple ways:

- **Balance and handling:** Passengers or cargo in the trailer can move around and shift the balance and center of gravity of the e-bike, which can affect the safe handling of the e-bike.
- **Cornering:** Entering corners must be done more slowly and carefully.
- **Stopping:** It takes more distance to slow and stop your e-bike.
- **Maneuvering:** Making quick direction changes is more difficult.
- **Accelerating:** More motor power is required to accelerate, which requires more battery energy.

 **WARNING: Towing a trailer behind your e-bike can result in instability of the e-bike and trailer. This can cause a crash, which can result in serious personal injury or death.**

9. Drive Systems

A. General Information About Your Drive System

Read, understand and follow all drive system manuals provided with your e-bike. Refer to the e-bike manufacturer's instructions for information on how to turn the system on or off. Only turn the e-bike on or off as instructed by the manufacturer.

 **WARNING: NEVER open the battery pack or modify the wiring or any electrical components of your e-bike. Opening the battery or modifying the wiring can result in electric shock and can cause a fire.**

 **WARNING: Do not expose the drive system to excessive water. Never fully submerge the drive system or use a pressure-washer to clean your e-bike. Exposure of the battery or internal components of the drive system to water can result in serious damage to the system components, resulting in electric shock or fire, leading to property damage, serious personal injury or death.**

 **WARNING: The drive system does not contain any user-serviceable parts. Any service should be performed by a qualified technician. Do not attempt to open, disassemble, modify, adjust or service any part of the drive**

system or its components. Any tampering with the internals of the motor, battery or other drive system components can result in damage to the system or lead to a battery fire, which can cause serious personal injury or death.

 **WARNING: E-bike drive system components are only intended for use on e-bikes. Do not use these components for any other purpose or vehicle.**

E-bikes are equipped with electronic components that may occasionally require software or firmware updates. Regularly check with your authorized retailer for any updates specific to your e-bike drive system.

The mechanical parts of the drivetrain on most e-bikes are often very similar to a drivetrain used on a regular bicycle, and often shift in the same way. Follow the same recommendations and best practices as a regular bicycle to shift in a way that is most beneficial to the durability and efficiency of your drivetrain.

For more information on servicing your e-bike, including the mechanical components, please refer to **Page 68, Section 12: “Maintaining and Servicing Your E-bike”**.

10. Fit

NOTE: Correct fit is an essential element of bicycling safety, performance and comfort. Making the adjustments to your e-bike that result in correct fit for your body and riding conditions requires experience, skill and special tools. Always have your authorized retailer make the adjustments on your e-bike. Or, if you have the experience, skill and tools, have your authorized retailer check your work before riding.

 **WARNING: If your e-bike does not fit properly, you may lose control and fall. If your new e-bike doesn't fit, ask your authorized retailer to exchange it before you ride it.**

 **WARNING: A child should never ride an e-bike that is too big for them. While some e-bikes have step-through frames (see fig. 2) that may allow a child to mount an e-bike, that does not mean the e-bike is the right size for them to operate safely. An e-bike that is too big for a child may lead to a loss of control and fall, resulting in serious personal injury or death.**

1. Is your e-bike the right size? To check, refer to **Page 44, Section 10: “Fit”, subsection A: “Standover Height”**. If your e-bike is too large or too small for you, you may lose control and fall. If your new e-bike is not the right size, ask your authorized retailer to exchange it before you ride it.
2. Is the saddle at the right height? To check, refer to **Page 44, Section 10: “Fit”, subsection B: “Saddle Position”**. If you adjust your saddle height, follow the Minimum Insertion instructions on **Page 44, Section 10: “Fit”, subsection B: “Saddle Position”**.
3. Are saddle and seat post securely clamped? A correctly tightened saddle will allow no saddle movement in any direction. Refer to **Page 44, Section 10: “Fit”, subsection B: “Saddle Position”**.
4. Are the stem and handlebars at the right height for you? If not, refer to **Page 46, Section 10: “Fit”, subsection C: “Handlebar Height and Angle”**.

- Can you comfortably operate the brakes? If not, you may be able to adjust their angle and reach. Refer to **Section 10: “Fit”, subsections D: “Control Position Adjustments” on Page 48 and E: “Brake Reach” on Page 48.**
- Do you fully understand how to operate your new e-bike? If not, before your first ride, have your authorized retailer explain any functions or features that you do not understand.

A. Standover Height

1. Diamond-frame e-bikes

Standover height is the basic element of e-bike fit (**fig. 7**). It is the distance from the ground to the top of the e-bike’s frame at that point where your crotch is when straddling the e-bike. To check for correct standover height, straddle the e-bike while wearing the kind of shoes in which you’ll be riding, and bounce vigorously on your heels. If your crotch touches the frame, the e-bike is too big for you. Don’t even ride the e-bike around the block. An e-bike which you ride only on paved surfaces and never take off-road should give you a minimum standover height clearance of two inches (5 cm). An e-bike that you’ll ride on unpaved surfaces should give you a minimum of three inches (7.5 cm) of standover height clearance. And an e-bike that you’ll use off-road should give you four inches (10 cm) or more of clearance.

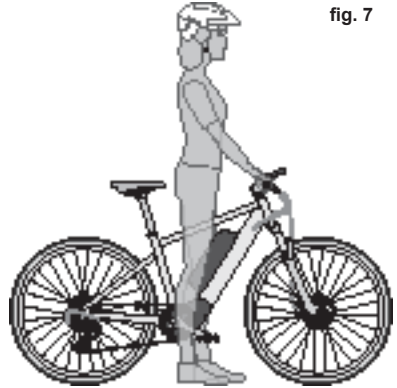

fig. 7

2. Step-through frame e-bikes

Standover height does not apply to e-bikes with step-through frames. Instead, the limiting dimension is determined by saddle height range. You must be able to adjust your saddle position as described in 3.B without exceeding the limits set by the height of the top of the seat tube and the “Minimum Insertion” or “Maximum Extension” mark on the seat post.

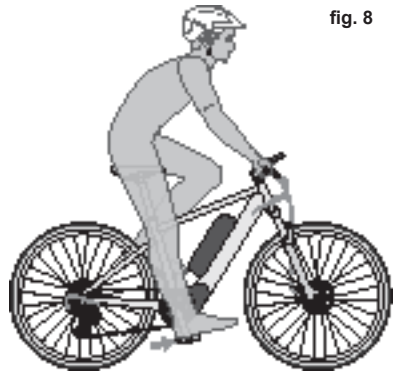

fig. 8

B. Saddle Position

Correct saddle adjustment is an important factor in getting the most performance and comfort from your e-bike. If the saddle position is not comfortable for you, see your authorized retailer. Small changes in saddle position can have a substantial effect on performance and comfort. To find your best saddle position, make only one adjustment at a time.

The saddle can be adjusted in three directions:

- Up and down adjustment.** To check for correct saddle height (**fig. 8**):
 - sit on the saddle
 - place one heel on a pedal
 - rotate the crank until the pedal with your heel on it is in the down position and the crank arm is parallel to the seat tube.

If your leg is not completely straight, your saddle height needs to be adjusted. If your hips must rock for the heel to reach the pedal, the saddle is too high. If your leg is bent at the knee with your heel on the pedal, the saddle is too low. Ask your authorized retailer to set the saddle for your optimal riding position and to show you how to make this adjustment. If you choose to make your own saddle height adjustment:

- loosen the seat post clamp
- raise or lower the seat post in the seat tube
- make sure the saddle is level fore and aft
- re-tighten the seat post clamp to the recommended torque (Appendix C or the manufacturer’s instructions).

Once the saddle is at the correct height, make sure that the seat post does not project from the frame beyond its “Minimum Insertion” or “Maximum Extension” mark (fig. 9).

NOTE: Some e-bikes have a sight hole in the seat tube, the purpose of which is to make it easy to see whether the seat post is inserted in the seat tube far enough to be safe. If your e-bike has such a sight hole, use it in addition to the “Minimum Insertion” or “Maximum Extension” mark to make sure the seat post is inserted in the seat tube far enough to be visible through the sight hole.

If your e-bike has an interrupted seat tube, as is the case on some suspension e-bikes, you must also make sure that the seat post is far enough into the frame so that you can touch it through the bottom of the interrupted seat tube with the tip of your finger without inserting your finger beyond its first knuckle.

Also see NOTE above and fig. 10.

⚠ WARNING: If your seat post is not inserted in the seat tube as described in B.1 above, the seat post, binder or even frame may break, which could cause you to lose control and fall.

- 2. Front and back adjustment.** The saddle can be adjusted forward or back to help you get the optimal position on the e-bike. Ask your authorized retailer to set the saddle for your optimal riding position and to show you how to make this adjustment. If you choose to make your own front and back adjustment, make sure that the clamp mechanism is clamping on the straight part of the saddle rails and is not touching the curved part of the rails, and that you are using the recommended torque on the clamping fastener(s) (Appendix C or the manufacturer’s instructions).
- 3. Saddle angle adjustment.** Most people prefer a horizontal saddle; but some riders like the saddle nose angled up or down just a little. Your authorized retailer can adjust saddle angle or teach you how to do it. If you choose to make your own saddle angle adjustment and you have a single bolt

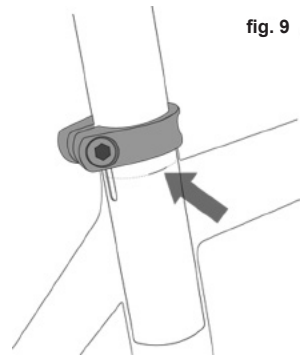

fig. 9



fig. 10

saddle clamp on your seat post, it is critical that you loosen the clamp bolt sufficiently to allow any serrations on the mechanism to disengage before changing the saddle's angle, and then that the serrations fully re-engage before you tighten the clamp bolt to the recommended torque (Appendix C or the manufacturer's instructions).

⚠ WARNING: When making saddle angle adjustments with a single bolt saddle clamp, always check to make sure that the serrations on the mating surfaces of the clamp are not worn. Worn serrations on the clamp can allow the saddle to move, causing you to lose control and fall.

⚠ WARNING: Always tighten fasteners to the correct torque. Bolts that are too tight can stretch and deform. Bolts that are too loose can move and fatigue. Either mistake can lead to a sudden failure of the bolt, causing you to lose control and fall.

NOTE: If your e-bike is equipped with a suspension seat post, the suspension mechanism may require periodic service or maintenance. Ask your authorized retailer for recommended service intervals for your suspension seat post.

⚠ WARNING: After any saddle adjustment, be sure that the saddle adjusting mechanism is properly seated and tightened before riding. A loose saddle clamp or seat post clamp can cause damage to the seat post, or can cause you to lose control and fall. A correctly tightened saddle adjusting mechanism will allow no saddle movement in any direction. Periodically check to make sure that the saddle adjusting mechanism is properly tightened.

If, in spite of carefully adjusting the saddle height, tilt and fore-and-aft position, your saddle is still uncomfortable, you may need a different saddle design. Saddles, like people, come in many different shapes, sizes and resilience. Your authorized retailer can help you select a saddle which, when correctly adjusted for your body and riding style, will be comfortable.

⚠ WARNING: Some people have claimed that extended riding with a saddle which is incorrectly adjusted or which does not support your pelvic area correctly can cause short-term or long-term injury to nerves and blood vessels, or even impotence. If your saddle causes you pain, numbness or other discomfort, listen to your body and stop riding until you see your authorized retailer about saddle adjustment or a different saddle.

C. Handlebar Height and Angle

Your e-bike is equipped either with a "threadless" stem, which clamps on to the outside of the steerer tube, or with a "quill" stem, which clamps inside the steerer tube by way of an expanding binder bolt. If you aren't absolutely sure which type of stem your e-bike has, ask your authorized retailer.

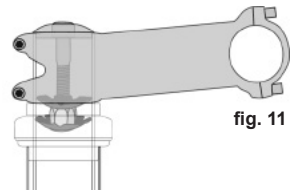

If your e-bike has a “threadless” stem (**fig. 11**) your authorized retailer may be able to change handlebar height by moving height adjustment spacers from below the stem to above the stem, or vice versa. Otherwise, you’ll have to get a stem of different length or rise. Consult your authorized retailer. Do not attempt to do this yourself, as it requires special knowledge.

If your e-bike has a “quill” stem (**fig. 12**) you can ask your authorized retailer to adjust the handlebar height a bit by adjusting stem height.

A quill stem has an etched or stamped mark on its shaft that designates the stem’s “Minimum Insertion” or “Maximum Extension”. This mark must not be visible above the headset.

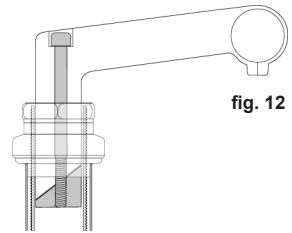

fig. 12

WARNING: A quill stem’s Minimum Insertion Mark must not be visible above the top of the headset. If the stem is extended beyond the Minimum Insertion Mark the stem may break or damage the fork’s steerer tube, which could cause you to lose control and fall.

WARNING: On some e-bikes, changing the stem or stem height can affect the tension of the front brake cable, locking the front brake or creating excess cable slack which can make the front brake inoperable. If the front brake pads move in toward the wheel rim or out away from the wheel rim when the stem or stem height is changed, the brakes must be correctly adjusted before you ride the e-bike.

Some e-bikes are equipped with an adjustable angle stem. If your e-bike has an adjustable angle stem, ask your authorized retailer to adjust it. Do not attempt to make the adjustment yourself, as changing stem angle may also require adjustments to the e-bike’s controls.

WARNING: Always tighten fasteners to the correct torque. Bolts that are too tight can stretch and deform. Bolts that are too loose can move and fatigue. Either mistake can lead to a sudden failure of the bolt, causing you to lose control and fall.

Your authorized retailer can also change the angle of the handlebar or bar end extensions.

WARNING: An insufficiently tightened stem clamp bolt, handlebar clamp bolt or bar end extension clamping bolt may compromise steering action, which could cause you to lose control and fall. Place the front wheel of the e-bike between your legs and attempt to twist the handlebar/stem assembly. If you can twist the stem in relation to the front wheel, turn the handlebars in relation to the stem, or turn the bar end extensions in relation to the handlebar, the bolts are insufficiently tightened.

WARNING: Be aware that adding aerodynamic extensions to handlebars will change the steering and braking response of the e-bike.

D. Control Position Adjustments

The angle of the brake and shift control levers and their position on the handlebars can be changed. Ask your authorized retailer to make the adjustments for you. If you choose to make your own control lever angle adjustment, be sure to re-tighten the clamp fasteners to the recommended torque (Appendix C or the manufacturer's instructions).

E. Brake Reach

Many e-bikes have brake levers that can be adjusted for reach. If you have small hands or find it difficult to squeeze the brake levers, your authorized retailer can either adjust the reach or fit shorter-reach brake levers.

 **WARNING: The shorter the brake lever reach, the more critical it is to have correctly adjusted brakes, so that full braking power can be applied within available brake lever travel. Brake lever travel insufficient to apply full braking power can result in loss of control, which may result in serious injury or death.**

11. Tech

It's important to your safety, performance and enjoyment to understand how things work on your e-bike. We urge you to ask your authorized retailer how to do the things described in this section before you attempt them yourself, and that you have your authorized retailer check your work before you ride the e-bike. If you have even the slightest doubt as to whether you understand something in this section of the Manual, talk to your authorized retailer. **See also Appendix A, B and C.**

A. Wheels

E-bike wheels are designed to be removable for easier transportation and for repair of a tire puncture. The wheel axles are inserted into slots, called "dropouts" in the fork and frame, but some e-bikes use what is called a "thru-axle" wheel mounting system.

If you have an e-bike with a thru-axle wheel mounting system, refer to **Page 51, Section 11: "Tech", subsection A.3: "Wheels - Thru-axle wheel mounting system"**.

If you do not have an e-bike with a thru-axle wheel mounting system, it will have wheels secured in one of three ways:

1. A hollow axle with a shaft ("skewer") running through it which has an adjustable tension nut on one end and an over-center cam lever on the other (cam-action system, **fig.13a & 13b**).
2. A hollow axle with a shaft ("skewer") running through it which has a nut on one end and a fitting for a hex key, lock lever or other tightening device on the other (through-bolt, **fig. 14**).
3. Hex nuts or hex key bolts which are threaded on to or into the hub axle (bolt-on wheel, **fig. 15**).

Your e-bike may be equipped with a different securing method for the front wheel than for the rear wheel. Discuss the wheel securing method for your e-bike with your authorized retailer.

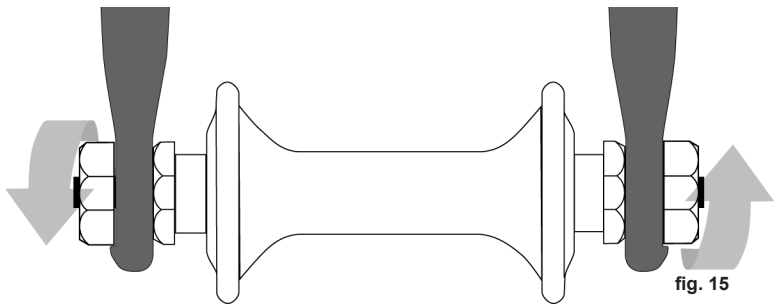
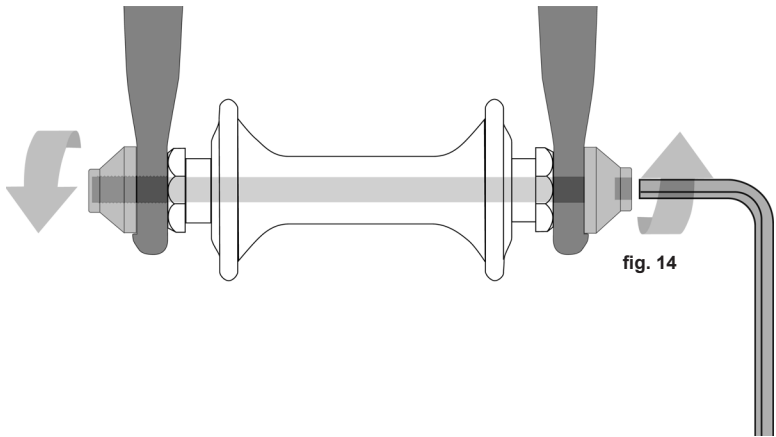
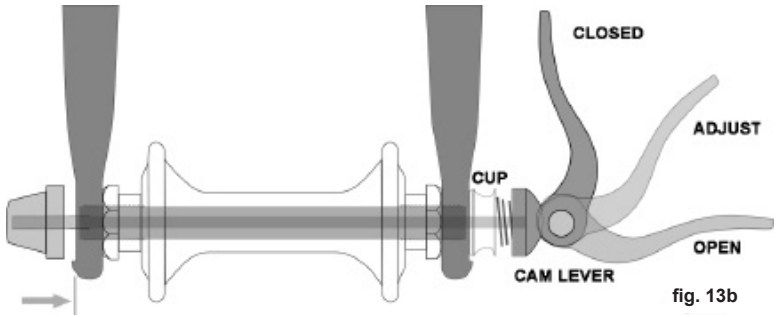
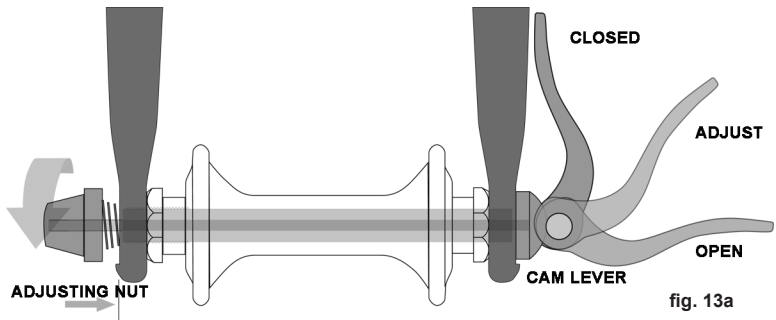

It is very important that you understand the type of wheel securing method on your e-bike, that you know how to secure the wheels correctly, and that you know how to apply the correct clamping force that safely secures the wheel. Ask your authorized retailer to instruct you in correct wheel removal and installation, and ask him to give you any available manufacturer's instructions.

 **WARNING:** Riding with an improperly secured wheel can allow the wheel to wobble or fall off the e-bike, which can cause serious injury or death. Therefore, it is essential that you:

1. Ask your authorized retailer to help you make sure you know how to install and remove your wheels safely.
2. Understand and apply the correct technique for clamping your wheel in place.
3. Each time before you ride the e-bike, check that the wheel is securely clamped.

The clamping action of a correctly secured wheel must emboss the surfaces of the dropouts.

1. Front wheel secondary retention devices

Most e-bikes equipped with an over-center cam, through-bolt or bolt-on front wheel retention have front forks with slotted dropouts that utilize a secondary wheel retention device to reduce the risk of the wheel disengaging from the fork if the wheel is incorrectly secured. Secondary retention devices are not a substitute for correctly securing your front wheel.

Secondary retention devices fall into two basic categories:

- a. The clip-on type is a part that the manufacturer adds to the front wheel hub or front fork.
- b. The integral type is molded, cast or machined into the outer faces of the front fork dropouts.

Ask your authorized retailer to explain the particular secondary retention device on your e-bike.

 **WARNING:** Do not remove or disable the secondary retention device. As its name implies, it serves as a back-up for a critical adjustment. If the wheel is not secured correctly, the secondary retention device can reduce the risk of the wheel disengaging from the fork. Removing or disabling the secondary retention device may also void the warranty.

Secondary retention devices are not a substitute for correctly securing your wheel. Failure to properly secure the wheel can cause the wheel to wobble or disengage, which could cause you to lose control and fall, resulting in serious injury or death.

2. Wheels with cam-action systems

There are currently two types of over-center cam wheel retention mechanisms: the traditional over-center cam (**fig. 13a**) and the cam-and-cup system (**fig. 13b**). Both use an over-center cam-action to clamp the e-bike's

wheel in place. Your e-bike may have a cam-and-cup front wheel retention system and a traditional rear wheel cam-action system.

a. Adjusting the traditional cam-action mechanism (fig. 13a)

The wheel hub is clamped in place by the force of the over-center cam pushing against one dropout and pulling the tension adjusting nut, by way of the skewer, against the other dropout. The amount of clamping force is controlled by the tension adjusting nut. Turning the tension adjusting nut clockwise while keeping the cam lever from rotating increases clamping force; turning it counterclockwise while keeping the cam lever from rotating reduces clamping force. Less than half a turn of the tension adjusting nut can make the difference between safe clamping force and unsafe clamping force.

 **WARNING: The full force of the cam-action is needed to clamp the wheel securely. Holding the nut with one hand and turning the lever like a wing nut with the other hand until everything is as tight as you can get it will not clamp a cam-action wheel safely in the dropouts. See also the first WARNING in this Section, Page 50.**

b. Adjusting the cam-and-cup mechanism (fig. 13b)

The cam-and-cup system on your front wheel will have been correctly adjusted for your e-bike by your authorized retailer. Ask your authorized retailer to check the adjustment every six months. **Do not use a cam-and-cup front wheel on any e-bike other than the one for which your authorized retailer adjusted it.**

3. Thru-axle wheel mounting system

If you have an e-bike equipped with thru-axle front or rear wheels, make sure that your authorized retailer has given you the manufacturer's instructions, and follow those when installing or removing a thru-axle wheel. If you don't know what a thru-axle is, ask your authorized retailer.

If your e-bike is equipped with a thru-axle, the thru-axle length, diameter, and thread pitch must match the specifications of your frame, fork and wheel hubs. Always install or remove your wheel in accordance with the thru-axle manufacturer's instructions, and consult the manufacturer if you have questions.

If you intend to replace the thru-axle, make sure that the new thru-axle is compatible with your e-bike. Do not remove the thru-axle from your e-bike and use it on a different e-bike, as it may not be compatible and will not properly secure your wheel.

 **WARNING: A wheel attachment device that is not properly secured can allow the wheel to loosen or come off, suddenly stop the wheel, decrease your control, and cause you to fall, resulting in serious injury or death. Ensure the thru-axle is not interfering with any part of the e-bike and is fully secured.**

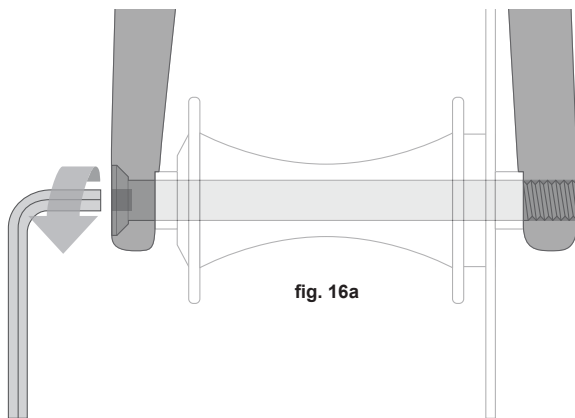

fig. 16a

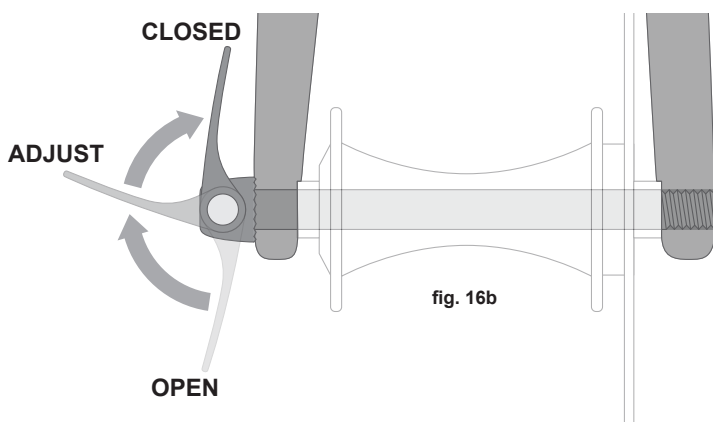

fig. 16b

a. Adjusting the thru-axle mechanism (fig. 16a & 16b)

The thru-axle is inserted through the unthreaded hole in the frame or fork's dropout, through the wheel hub, and is threaded directly into the opposing dropout by tightening the thru-axle. Common installation methods may use an Allen hex key (fig. 16a) or a cam lever (fig. 16b). Please refer to the manufacturer's instructions for specific information about your thru-axle's operation, including correct torque specifications or lever adjustment information.

4. Removing and installing wheels

! WARNING: If your e-bike is equipped with an internal gear rear hub, do not attempt to remove the wheel. The removal and re-installation of most internal gear hubs requires special knowledge. Incorrect removal or assembly can result in gear failure, which can cause you to lose control and fall.

! CAUTION: If your e-bike has a disc brake, exercise care in touching the rotor or caliper. Disc rotors have sharp edges, and both rotor and caliper can get very hot during use.

a. Removing a disk brake or rim brake Front Wheel

1. If your e-bike has rim brakes, disengage the brake's quick-release mechanism to increase the clearance between the tire and the brake pads. **Refer to Page 57, Section 11: "Tech", subsection C: "Brakes", figs. 18 through 22.**
2. If your e-bike has a cam-action front wheel retention, move the cam lever from the locked or CLOSED position to the OPEN position (**figs. 13a & 13b**). If your e-bike has through-bolt or bolt-on front wheel retention, loosen the fastener(s) a few turns counter-clockwise using an appropriate wrench, lock key or the integral lever.
3. If your front fork has a clip-on type secondary retention device, disengage it. If your front fork has an integral secondary retention device, and a traditional cam-action system (**fig. 13a**) loosen the tension adjusting nut enough to allow removing the wheel from the dropouts. If your front wheel uses a cam-and-cup system, (**fig. 13b**) squeeze the cup and cam lever together while removing the wheel. No rotation of any part is necessary with the cam-and-cup system.
4. If your e-bike has a thru-axle front wheel mounting system (**figs. 13a & 13b**), loosen and remove the thru-axle according to the manufacturer's instructions, then remove the front wheel.

You may need to tap the top of the wheel with the palm of your hand to release the wheel from the front fork.

b. Installing a disk brake or rim brake Front Wheel

 **CAUTION: If your e-bike is equipped with a front disk brake, be careful not to damage the disk, caliper or brake pads when re-inserting the disk into the caliper. Never activate a disk brake's control lever unless the disk is correctly inserted in the caliper. Refer to Page 57, Section 11: "Tech", subsection C: "Brakes".**

1. If your e-bike has a cam-action front wheel retention, move the cam lever so that it curves away from the wheel (**figs. 13a & 13b**). This is the OPEN position. If your e-bike has a thru-axle, through-bolt or bolt-on front wheel retention, go to the next step.
2. With the steering fork facing forward, insert the wheel between the fork blades so that the axle seats firmly at the top of the fork dropouts. The cam lever, if there is one, should be on rider's left side of the e-bike (**fig. 13a & 13b**). If your e-bike has a clip-on type secondary retention device, engage it.
3. If your e-bike has a thru-axle front wheel mounting system, insert the thru-axle through the unthreaded dropout side and through the hub body, then thread the thru-axle into the threads of the opposing dropout.
4. If your e-bike has a traditional cam-action mechanism: holding the cam lever in the ADJUST position with your right hand, tighten the tension adjusting nut with your left hand until it is finger tight against the fork dropout (**fig. 13a**). If you have a cam-and-cup system: the nut and cup (**fig. 13b**) will have snapped into the recessed area of the fork dropouts and no adjustment should be required.
5. While pushing the wheel firmly to the top of the slots in the fork dropouts, and at the same time centering the wheel rim in the fork:
 - (a) With a cam-action system, move the cam lever upwards and swing

it into the CLOSED position (**fig. 13a & 13b**). The lever should now be parallel to the fork blade and curved toward the wheel. To apply enough clamping force, you should have to wrap your fingers around the fork blade for leverage, and the lever should leave a clear imprint in the palm of your hand.

(b) With a through-bolt or bolt-on system, tighten the fasteners to the torque specifications in Appendix C or the hub manufacturer's instructions. (c) With a thru-axle system, tighten the thru-axle (**figs. 13a & 13b**) according to the manufacturer's instructions.

NOTE: If, on a traditional cam-action system, the lever cannot be pushed all the way to a position parallel to the fork blade, return the lever to the OPEN position. Then turn the tension adjusting nut counterclockwise one-quarter turn and try tightening the lever again.

 **WARNING: Securely clamping the wheel with a cam-action retention device takes considerable force. If you can fully close the cam lever without wrapping your fingers around the fork blade for leverage, the lever does not leave a clear imprint in the palm of your hand, and the serrations on the wheel fastener do not emboss the surfaces of the dropouts, the tension is insufficient. Open the lever; turn the tension adjusting nut clockwise a quarter turn; then try again. See also the first WARNING in this Section, Page 50.**

6. If you disengaged the brake quick-release mechanism in 4. a. (1) above, re-engage it to restore correct brake pad-to-rim clearance.
7. Spin the wheel to make sure that it is centered in the frame and clears the brake pads; then squeeze the brake lever and make sure that the brakes are operating correctly.

c. Removing a disk brake or rim brake Rear Wheel

1. If you have a multi-speed e-bike with a derailleur gear system, shift the rear derailleur to high gear (the smallest, outermost rear sprocket). If you have an internal gear rear hub, do not attempt to remove the rear wheel. Consult your authorized retailer or the hub manufacturer's instructions for additional information. If you have a single-speed e-bike with rim or disk brake, go to step (4) below.
2. If your e-bike has rim brakes, disengage the brake's quick-release mechanism to increase the clearance between the wheel rim and the brake pads. **Refer to Page 57, Section 11: "Tech", subsection C: "Brakes", figs. 18 through 22.**
3. On a derailleur gear system, pull the derailleur body back with your right hand.
4. If your e-bike has a cam-action front wheel retention, move the cam lever from the locked or CLOSED position to the OPEN position (**figs. 13a & 13b**). If your e-bike has through-bolt or bolt-on front wheel retention, loosen the fastener(s) a few turns counter-clockwise using an appropriate wrench, lock key or the integral lever.
5. If your e-bike has a thru-axle rear wheel mounting system (**figs. 13a & 13b**), loosen and remove the thru-axle according to the manufacturer's instructions.
6. Push the rear wheel forward far enough to be able to remove the chain from the rear sprocket, then lift the rear wheel off the ground a few inches and remove it from the rear dropouts.

d. Installing a disk brake or rim brake Rear Wheel



CAUTION: If your e-bike is equipped with a rear disk brake, be careful not to damage the disk, caliper or brake pads when re-inserting the disk into the caliper. Never activate a disk brake's control lever unless the disk is correctly inserted in the caliper.

1. With a cam-action system, move the cam lever to the OPEN position (see **figs. 13a & 13b**). The lever should be on the side of the wheel opposite the derailleur and freewheel sprockets.
 - (a) On a derailleur e-bike, make sure that the rear derailleur is still in its outermost, high gear, position; then pull the derailleur body back with your right hand. Put the chain on top of the smallest freewheel sprocket.
 - (b) On a single-speed e-bike, remove the chain from the front sprocket, so that you have plenty of slack in the chain. Put the chain on the rear wheel sprocket.
2. Then, insert the wheel into the frame dropouts and pull it all the way into the dropouts.

NOTE: On an e-bike with a single rear gear, replace the chain on the rear sprocket and front chainring; then pull the wheel back in the dropouts so that it is straight in the frame and the chain has about 1/4 inch of up-and-down play.

(a) With a cam-action system, move the cam lever upwards and swing it into the CLOSED position (**figs. 13a & 13b**). The lever should now be parallel to the seat stay or chain stay and curved toward the wheel.

To apply enough clamping force, you should have to wrap your fingers around the fork blade for leverage, and the lever should leave a clear imprint in the palm of your hand.

(b) With a through-bolt or bolt-on system, tighten the fasteners to the torque specifications in Appendix C or the hub manufacturer's instructions. (c) With a thru-axle system, tighten the thru-axle (**figs. 13a & 13b**) according to the manufacturer's instructions.

NOTE: If, on a traditional cam-action system, the lever cannot be pushed all the way to a position parallel to the seat stay or chain stay, return the lever to the OPEN position. Then turn the tension adjusting nut counterclockwise one-quarter turn and try tightening the lever again.



WARNING: Securely clamping the wheel with a cam-action retention device takes considerable force. If you can fully close the cam lever without wrapping your fingers around the seat stay or chain stay for leverage, the lever does not leave a clear imprint in the palm of your hand, and the serrations on the wheel fastener do not emboss the surfaces of the dropouts, the tension is insufficient. Open the lever; turn the tension adjusting nut clockwise a quarter turn; then try again. See also the first **WARNING** in this Section, Page 50.

3. If you disengaged the brake quick-release mechanism in 4. c. (2) above, re-engage it to restore correct brake pad-to-rim clearance.
4. Spin the wheel to make sure that it is centered in the frame and clears the brake pads; then squeeze the brake lever and make sure that the brakes are operating correctly.

B. Seat Post Cam-action Clamp

Some e-bikes are equipped with a cam-action seat post binder. The seat post cam-action binder works exactly like the traditional wheel cam-action fastener. Refer to **Page 50, Section 11: “Tech”, subsection A.2: “Wheels with cam-action systems”**. While a cam-action binder looks like a long bolt with a lever on one end and a nut on the other, the binder uses an over-center cam-action to firmly clamp the seat post (see fig. 12a).



WARNING: Riding with an improperly tightened seat post can allow the saddle to turn or move and cause you to lose control and fall. Therefore:

- 1. Ask your authorized retailer to help you make sure you know how to correctly clamp your seat post.**
- 2. Understand and apply the correct technique for clamping your seat post.**
- 3. Before you ride the e-bike, first check that the seat post is securely clamped.**

Adjusting the seat post cam-action mechanism

The action of the cam squeezes the seat collar around the seat post to hold the seat post securely in place. The amount of clamping force is controlled by the tension adjusting nut. Turning the tension adjusting nut clockwise while keeping the cam lever from rotating increases clamping force; turning it counterclockwise while keeping the cam lever from rotating reduces clamping force. Less than half a turn of the tension adjusting nut can make the difference between safe and unsafe clamping force.



WARNING: The full force of the cam-action is needed to clamp the seat post securely. Holding the nut with one hand and turning the lever like a wing nut with the other hand until everything is as tight as you can get it will not clamp the seat post safely.



WARNING: If you can fully close the cam lever without wrapping your fingers around the seat post or a frame tube for leverage, and the lever does not leave a clear imprint in the palm of your hand, the tension is insufficient. Open the lever; turn the tension adjusting nut clockwise a quarter turn; then try again.

C. Brakes

There are three general types of bicycle brakes: rim brakes, which operate by squeezing the wheel rim between two brake pads; disc brakes, which operate by squeezing a hub-mounted disc between two brake pads; and internal hub brakes. All three can be operated by way of a handlebar-mounted lever.

WARNING:

1. Riding with improperly adjusted brakes, worn brake pads, or wheels on which the rim wear mark is visible is dangerous and can result in serious injury or death.
2. Applying brakes too hard or too suddenly can lock up a wheel, which could cause you to lose control and fall (see fig. 17). Sudden or excessive application of the front brake may pitch the rider over the handlebars, which may result in serious injury or death.
3. Some bicycle brakes, such as disc brakes (fig. 18) and linear-pull brakes (fig. 19), are extremely powerful. Take extra care in becoming familiar with these brakes and exercise particular care when using them.
4. Some bicycle brakes are equipped with a brake force modulator, a small, cylindrical device through which the brake control cable runs and which is designed to provide a more progressive application of braking force. A modulator makes the initial brake lever force more gentle, progressively increasing force until full force is achieved. If your e-bike is equipped with a brake force modulator, take extra care in becoming familiar with its performance characteristics. Some brake force modulators are adjustable. If you don't like the feel of your brakes, ask your authorized retailer about adjusting the brake force modulation.
5. Disc brakes can get extremely hot with extended use. Be careful not to touch a disc brake until it has had plenty of time to cool.
6. See the brake manufacturer's instructions for operation and care of your brakes, and for when brake pads must be replaced. If you do not have the manufacturer's instructions, see your authorized retailer or contact the brake manufacturer.
7. If replacing worn or damaged parts, use only manufacturer-approved genuine replacement parts.

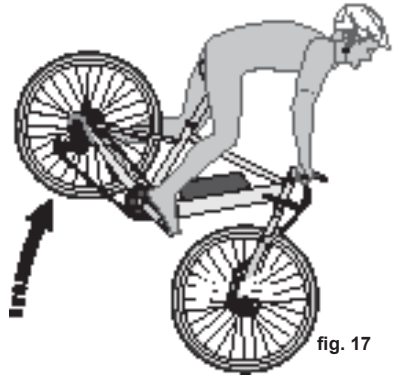

fig. 17

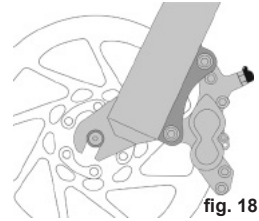

fig. 18

1. Brake controls and features

It's very important to your safety that you learn and remember which brake lever controls which brake on your e-bike. Traditionally, in the U.S. the right brake lever controls the rear brake and the left brake lever controls the front brake; but, to check how your e-bike's brakes are set up, squeeze one brake lever and look to see which brake, front or rear, engages. Now do the same with the other brake lever.

Make sure that your hands can reach and squeeze the brake levers comfortably. If your hands are too small to operate the levers comfortably, consult your authorized retailer before riding the e-bike. The lever reach may be adjustable; or you may need a different brake lever design.

Most rim brakes have some form of quick-release mechanism to allow the brake pads to clear the tire when a wheel is removed or reinstalled. When the brake quick-release is in the open position, the brakes are inoperative. Ask your authorized retailer to make sure that you understand the way the brake quick-release works on your e-bike (see figs. 19, 20, 21 & 22) and check each time to make sure both brakes work correctly before you get on the e-bike.

2. How brakes work

The braking action of an e-bike is a function of the friction between the braking surfaces. To make sure that you have maximum friction available, keep your wheel rims and brake pads or the disk rotor and caliper clean and free of dirt, lubricants, waxes or polishes.

Brakes are designed to control your speed, not just to stop the e-bike. Maximum braking force for each wheel occurs at the point just before the wheel "locks up" (stops rotating) and starts to skid. Once the tire skids, you actually lose most of your stopping force and all directional control. You need to practice slowing and stopping smoothly without locking up a wheel. The technique is called progressive brake modulation. Instead of jerking the brake lever to the position where you think you'll generate appropriate braking force, squeeze the lever, progressively increasing the braking force. If you feel the wheel begin to lock up, release pressure just a little to keep the wheel rotating just short of lockup. It's important to develop a feel for the amount of brake lever pressure required for each wheel at different speeds and on different surfaces. To better understand this, experiment a little by walking your e-bike and applying different amounts of pressure to each brake lever, until the wheel locks.

When you apply one or both brakes, the e-bike begins to slow, but your body wants to continue at the speed at which it was going. This causes a transfer of weight to the front wheel (or, under heavy braking, around the front wheel hub,

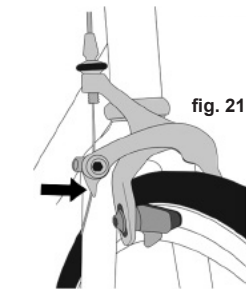
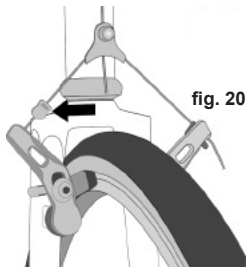
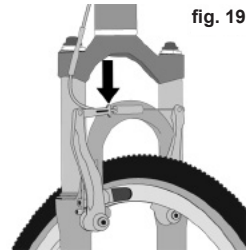

which could send you flying over the handlebars).

A wheel with more weight on it will accept greater brake pressure before lockup; a wheel with less weight will lock up with less brake pressure.

So, as you apply brakes and your weight is transferred forward, you need to shift your body toward the rear of the e-bike, to transfer weight back onto the rear wheel; and at the same time, you need to both decrease rear braking and increase front braking force. This is even more important on descents, because descents shift weight forward.

Two keys to effective speed control and safe stopping are controlling wheel lockup and weight transfer. This weight transfer is even more pronounced if your e-bike has a front suspension fork. Front suspension “dips/compresses/dives” under braking, increasing the weight transfer (see also **Page 62, Section 11: “Tech, subsection F: “Bicycle Suspension”**). Practice braking and weight transfer techniques where there is no traffic or other hazards and distractions.

Everything changes when you ride on loose surfaces or in wet weather. It will take longer to stop on loose surfaces or in wet weather. Tire adhesion is reduced, so the wheels have less cornering and braking traction and can lock up with less brake force. Moisture or dirt on the brake pads reduces their ability to grip. The way to maintain control on loose or wet surfaces is to go more slowly.

D. Shifting Gears

Your multi-speed e-bike may have a derailleur drivetrain (see 1. below), an internal gear hub drivetrain (see 2. below) or, in some special cases, a combination of the two.

1. How a derailleur drivetrain works

If your e-bike has a derailleur drivetrain, the gear-changing mechanism will have:

- a rear cassette or freewheel sprocket cluster
- a rear derailleur
- usually a front derailleur
- one or two shifters
- one, two or three front sprockets called chainrings
- a drive chain

a. Shifting gears

There are several different types and styles of shifting controls: levers, twist grips, triggers, combination shift/brake controls and push-buttons. Ask your authorized retailer to explain the type of shifting controls that are on your e-bike, and to show you how they work.

The vocabulary of shifting can be pretty confusing. A downshift is a shift to a “lower” or “slower” gear, one that is easier to pedal. An upshift is a shift to a “higher” or “faster”, harder-to-pedal gear. What’s confusing is that what’s happening at the front derailleur is the opposite of what’s happening at the rear derailleur (for details, read the instructions on Shifting the Rear Derailleur and Shifting the Front Derailleur below). For example, you can select a gear which will make pedaling easier on a hill (make a downshift) in one of two ways: shift the chain down the gear “steps” to a smaller gear at the front, or up the gear “steps” to a larger gear at the rear. So, at the rear gear cluster, what is called a downshift looks like an upshift. The way to keep things straight is to remember that shifting the chain in towards the centerline of the e-bike is for accelerating and climbing and is called a downshift. Moving the chain out or away from the centerline of the e-bike is for speed and is called an upshift.

Whether upshifting or downshifting, the e-bike derailleur system design requires that the drive chain be moving forward and be under at least some tension. A derailleur will shift only if you are pedaling forward.

⚠ CAUTION: Never move the shifter while pedaling backward, nor pedal backwards immediately after having moved the shifter. This could jam the chain and cause serious damage to the e-bike.

b. Shifting the Rear Derailleur

The rear derailleur is controlled by the right shifter. The function of the rear derailleur is to move the drive chain from one gear sprocket to another. The smaller sprockets on the gear cluster produce higher gear ratios. Pedaling in the higher gears requires greater pedaling effort, but takes you a greater distance with each revolution of the pedal cranks. The larger sprockets produce lower gear ratios. Using them requires less pedaling effort, but takes you a shorter distance with each pedal crank revolution. Moving the chain from a smaller sprocket of the gear cluster to a larger sprocket results in a downshift. Moving the chain from a larger sprocket to a smaller sprocket results in an upshift. In order for the derailleur to move the chain from one sprocket to another, the rider must be pedaling forward.

c. Shifting the Front Derailleur:

The front derailleur, which is controlled by the left shifter, shifts the chain between the larger and smaller chainrings. Shifting the chain onto a smaller chainring makes pedaling easier (a downshift). Shifting to a larger chainring makes pedaling harder (an upshift).

d. Which gear should I be in?

The combination of largest rear and smallest front sprockets (**fig. 23**) is for the steepest hills. The smallest rear and largest front combination is for the greatest speed. It is not necessary to shift gears in sequence. Instead, find the “starting gear” which is right for your level of ability — a gear which is hard enough for quick acceleration but easy enough to let you start from a stop without wobbling — and experiment with upshifting and downshifting to get a feel for the different gear combinations. At first, practice shifting where there are no obstacles, hazards or other traffic, until you’ve built up your confidence. Learn not to use either the “smallest to smallest” or “largest to largest” gear combinations because they may cause unacceptable stress on the drive train. Learn to anticipate the need to shift, and shift to a lower gear before the hill gets too steep. If you have difficulties with shifting, the problem could be mechanical adjustment. See your authorized retailer for help.

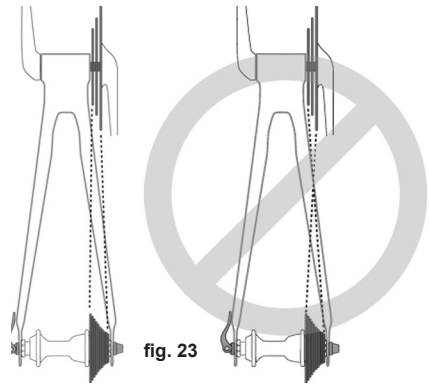

fig. 23

⚠ WARNING: Never shift a derailleur onto the largest or the smallest sprocket if the derailleur is not shifting smoothly. The derailleur may be out of adjustment and the chain could jam, causing you to lose control and fall.

e. What if it won't shift gears?

If moving the shift control one click repeatedly fails to result in a smooth shift to the next gear, chances are that the mechanism is out of adjustment. Take the e-bike to your authorized retailer to have it adjusted.

2. How an internal gear hub drivetrain works

If your e-bike has an internal gear hub drivetrain, the gear changing mechanism will consist of:

- a finite set of speeds (anywhere from three to 18 speeds or more), or possibly an infinitely variable internal gear hub
- one, or sometimes two shifters
- one or two control cables
- one front sprocket, also called a chainring
- one rear sprocket, also called a cog
- a drive chain

a. Shifting internal gear hub gears

Shifting with an internal gear hub drivetrain is simply a matter of moving the shifter to the indicated position for the desired gear ratio. After you have moved the shifter to the gear position of your choice, ease the pressure on the pedals for an instant to allow the hub to complete the shift.

b. Which gear should I be in?

The numerically lowest gear (1) is for the steepest hills. The numerically largest gear is for the greatest speed.

Shifting from an easier, “slower” gear (like 1) to a harder, “faster” gear (like 2 or 3) is called an upshift. Shifting from a harder, “faster” gear to an easier, “slower” gear is called a downshift. It is not necessary to shift gears in sequence. Instead, find the “starting gear” for the conditions — a gear which is hard enough for quick acceleration but easy enough to let you start from a stop without wobbling — and experiment with upshifting and downshifting to get a feel for the different gears. At first, practice shifting where there are no obstacles, hazards or other traffic, until you've built up your confidence. Learn to anticipate the need to shift, and shift to a lower gear before the hill gets too steep. If you have difficulties with shifting, the problem could be mechanical adjustment. See your authorized retailer for help.

c. What if it won't shift gears?

If moving the shift control one click repeatedly fails to result in a smooth shift to the next gear, chances are that the mechanism is out of adjustment. Take the e-bike to your authorized retailer to have it adjusted.

E. Pedals

Toe overlap is when your toe can touch the front wheel when you turn the handlebars to steer while a pedal is in the forward-most position. This is common on small-framed e-bikes, and is avoided by keeping the inside pedal up and the outside pedal down when making sharp turns. On any e-bike, this technique will also prevent the inside pedal from striking the ground in a turn.

NOTE: Changing tire size or pedal crank arm length affects toe overlap.



WARNING: Toe overlap could cause you to lose control and fall. Ask your authorized retailer to help you determine if the combination of frame size, crank arm length, pedal design and shoes you will use results in toe overlap. Whether you have overlap or not, you must keep the inside pedal up and the outside pedal down when making sharp turns.

Some e-bikes come equipped with pedals that have sharp and potentially dangerous surfaces. These surfaces are designed to increase grip between the rider's shoe and the pedal. If your e-bike has this type of high-performance pedal, you must take extra care to avoid serious injury from the pedals' sharp surfaces. Based on your riding style or skill level, you may prefer a less aggressive pedal design, or choose to ride with shin pads. Your authorized retailer can show you a number of options and make suitable recommendations.

Cliplless pedals (sometimes called "step-in pedals") are another means to keep feet securely in the correct position for maximum pedaling efficiency. They have a plate, called a "cleat," on the sole of the shoe, which clicks into a mating spring-loaded fixture on the pedal. They only engage or disengage with a very specific twisting motion that must be practiced until it becomes instinctive. Cliplless pedals require shoes and cleats which are compatible with the make and model pedal being used.

Many cliplless pedals are designed to allow the rider to adjust the amount of force needed to engage or disengage the foot. Follow the pedal manufacturer's instructions, or ask your authorized retailer to show you how to make this adjustment. Use the easiest setting until engaging and disengaging becomes a reflex action, but always make sure that there is sufficient tension to prevent unintended release of your foot from the pedal.



WARNING: Cliplless pedals are intended for use with shoes specifically made to fit them and are designed to firmly keep the foot engaged with the pedal. Do not use shoes which do not engage the pedals correctly.

Practice is required to learn to engage and disengage the foot safely. Until engaging and disengaging the foot becomes a reflex action, the technique requires concentration which can distract your attention and cause you to lose control and fall. Practice engaging and disengaging cliplless pedals in a place where there are no obstacles, hazards or traffic; and be sure to follow the pedal manufacturer's setup and service instructions. If you do not have the manufacturer's instructions, see your authorized retailer or contact the manufacturer.

F. Bicycle Suspension

Many e-bikes are equipped with suspension systems. There are many different types of suspension systems — too many to deal with individually in this Manual. If your e-bike has a suspension system of any kind, be sure to read and follow the suspension manufacturer's setup and service instructions. If you do not have the manufacturer's instructions, see your authorized retailer or contact the manufacturer.



WARNING: Failure to maintain, check and properly adjust the suspension system may result in suspension malfunction, which may cause you to lose control and fall.

If your e-bike has suspension, the increased speed you may develop also increases your risk of injury. For example, when braking, the front of a suspended e-bike dips, compresses or dives. You could lose control and fall if you do not have experience with this system. Learn to handle your suspension system safely.

⚠️ WARNING: Changing suspension adjustment can change the handling and braking characteristics of your e-bike. Never change suspension adjustment unless you are thoroughly familiar with the suspension system manufacturer’s instructions and recommendations, and always check for changes in the handling and braking characteristics of the e-bike after a suspension adjustment by taking a careful test ride in a hazard-free area.

Suspension can increase control and comfort by allowing the wheels to better follow the terrain. This enhanced capability may allow you to ride faster; but you must not confuse the enhanced capabilities of the e-bike with your own capabilities as a rider. Increasing your skill will take time and practice. Proceed carefully until you have learned to handle the full capabilities of your e-bike.

⚠️ WARNING: Not all e-bikes can be safely retrofitted with some types of suspension systems. Before retrofitting an e-bike with any suspension, check with the e-bike’s manufacturer to make sure that what you want to do is compatible with the e-bike’s design. Failing to do so can result in catastrophic frame failure.

G. Tires and Tubes

1. Tires

Bicycle tires are available in many designs and specifications, ranging from general-purpose designs to tires designed to perform best under very specific weather or terrain conditions. If, once you’ve gained experience with your new e-bike, you feel that a different tire might better suit your riding needs, your authorized retailer can help you select the most appropriate design.

The size, pressure rating, and on some high-performance tires the specific recommended use, are marked on the sidewall of the tire (fig. 24). Some wheel rim manufacturers also specify maximum tire pressure with a label on the rim.

The best and safest way to inflate a bicycle tire to the correct pressure is with a bicycle pump that has a built-in pressure gauge.

⚠️ WARNING: There is a safety risk in using gas station air hoses or other air compressors. They are not made for bicycle tires. They move

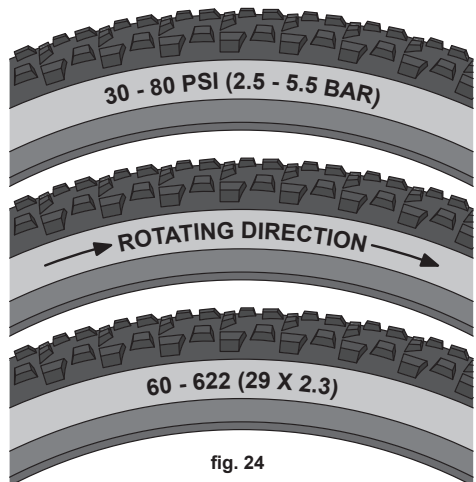



fig. 24

a large volume of air very rapidly, and will raise the pressure in your tire very rapidly, which could cause the tube to explode.

 **CAUTION:** Pencil-type automotive tire gauges can be inaccurate and should not be relied upon for consistent, accurate pressure readings. Instead, use a high-quality dial or digital gauge.

Tire pressure is given either as maximum pressure or as a pressure range. How a tire performs under different terrain or weather conditions depends largely on tire pressure. Inflating the tire to near its maximum recommended pressure gives the lowest rolling resistance; but also produces the harshest ride. High pressures work best on smooth, dry pavement.

Very low pressures, at the bottom of the recommended pressure range, give the best performance on smooth, slick terrain such as hard-packed clay, and on deep, loose surfaces such as deep, dry sand.

Tire pressure that is too low for your weight and the riding conditions can cause a puncture of the tube by allowing the tire to deform sufficiently to pinch the inner tube between the rim and the riding surface. This may also result in rim damage.

 **WARNING:** Never inflate a tire beyond the maximum pressure marked on the tire's sidewall or the wheel rim. If the maximum pressure rating for the wheel rim is different from the maximum pressure shown on the tire, always use the lower rating. Exceeding the recommended maximum pressure may blow the tire off the rim or damage the wheel rim during installation or while riding, resulting in a loss of control or crash causing serious injury or death, as well as damage to the tire, tube, and/or wheel rim.

 **WARNING:** Never ride a tire inflated below the minimum pressure marked on the tire's sidewall. Tire pressure below the minimum may cause a flat tire and/or the tire to detach from the rim while riding, resulting in a loss of control or crash causing serious injury or death, as well as damage to the tire, tube, and/or wheel rim.

Ask your authorized retailer to recommend the best tire pressure for the kind of riding you will most often do, and have your authorized retailer inflate your tires to that pressure. Then, check inflation as described on **Page 22, Section 7:** "Safely Operating Your E-bike", **subsection B:** "Mechanical Safety Check", so you'll know how correctly inflated tires should look and feel when you don't have access to a gauge. Some tires may need to be brought up to pressure every week or two, so it is important to check your tire pressures before every ride.

Some special high-performance tires have unidirectional treads: their tread pattern is designed to work better in one direction than in the other. The sidewall marking of a unidirectional tire will have an arrow showing the correct rotation direction. If your e-bike has unidirectional tires, be sure that they are mounted to rotate in the correct direction.

2. Tubeless rims and tires

Some e-bikes come equipped with rims (the circular, outermost portion of the wheel to which the tire is mounted) and tires that can be set up without the use of an inner tube. Tubeless rims and tires have special rim and tire bead profiles that form a seal and retain air when properly mounted. Tubeless rims come in

a variety of styles and may require additional components such as a rim tape, valve cores, sealant and tubeless-compatible tires to complete the tubeless setup. The rim manufacturer may identify the rims as “tubeless compatible” or “tubeless ready” depending on which components are required. If you choose to utilize the tubeless features of your rims, carefully review the rim manufacturer’s instructions regarding what additional components you need to convert to or maintain a tubeless setup.

Tubeless rims have a wide range of profiles that can affect the type of tubeless tire that can be mounted to the rim. For example, your rim manufacturer may refer to the rim profile as “hooked” or “hookless” depending on whether there is a hook protruding on the inside of the rim. Likewise, the bead profile of tubeless tires differs between tire manufacturers. Given the wide range of tubeless tires and rims available, the compatibility of tubeless tires with different types of tubeless rims varies significantly. If you choose to run a tubeless setup, make sure the tires and rims are compatible. Only use tubeless tires that have been approved by the rim manufacturer or tire manufacturer for use on your rims. If you have questions about tubeless tire and rim compatibility, talk to your local authorized retailer.

Mounting tubeless tires on a tubeless rim requires specialized knowledge, skills and equipment. A tubeless setup may require the installation of additional components, including rim tape, valve cores and sealant. Carefully review the instructions from both the rim and tire manufacturer regarding how to set up tubeless tires before attempting to do so. If you have any concerns about properly setting up your rims and tires to run as a tubeless setup, ask your local authorized retailer to mount the tires for you.

⚠ WARNING: Riding on an improperly installed, incompatible or damaged tubeless tire and rim combination can cause the tire to unexpectedly lose pressure and detach from the rim, resulting in a crash causing serious injury or death. Ensure the components are compatible according to the component manufacturers before installation.

⚠ CAUTION: During installation, an incompatible or damaged tubeless tire and rim combination can cause the tire to unexpectedly lose pressure and tire sealant and detach from the rim, resulting in damage to the wheel or other components, and may injure the installer. Use of eye and ear protection is recommended. Ensure the components are compatible according to the component manufacturers before installation.

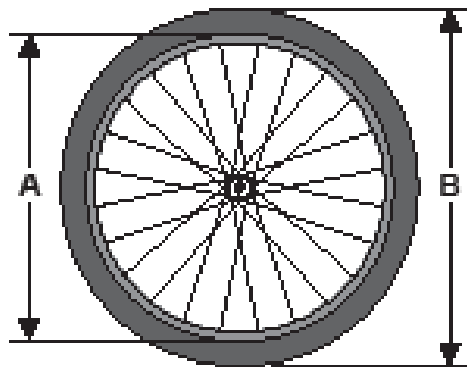

fig. 25

3. Tire and rim width/diameter

Wheel rims and tires come in a wide range of diameters (**fig. 25**) and widths (**fig. 26**). The nominal diameter of the rim (A) must match the nominal diameter of the tire (B), and the width of the rim (C) must be compatible with the width of the tire (D).

Always follow the rim and tire manufacturer's recommendations concerning tire models and sizes that are compatible with your specific rims.

⚠ WARNING: Failure to use a compatible tire and rim combination can cause the tire to unexpectedly lose pressure and detach from the rim, resulting in a crash causing serious injury or death. Ensure the components are compatible according to the component manufacturers before installation.

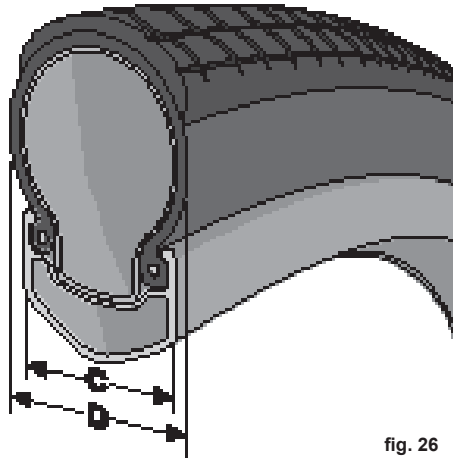

fig. 26

4. Tire clearance

The diameter and width of the original equipment wheels and tires on your e-bike have been selected to ensure they provide adequate clearance between the rotating tire and wheel, and the frame, fork or other components. Any change to your wheels or tires can affect this clearance.

Tires that are marked as being the same size may have different widths when installed, properly inflated and mounted on your e-bike. Always verify your tire clearance with the tires mounted and fully inflated even if the replacement tires are marked as being the same size as the tires that are being replaced.

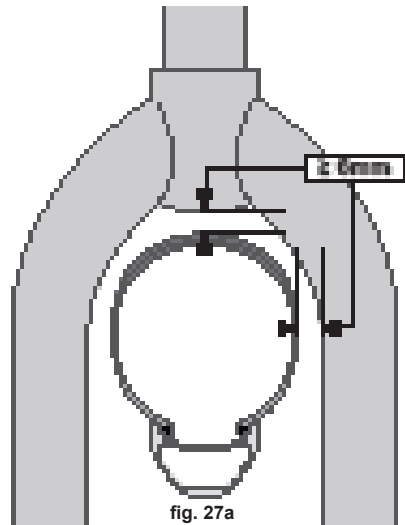

fig. 27a

Minimum clearance between a properly inflated tire and any part of the e-bike typically should be at least 6mm (**fig. 27a & 27b**). Some regulations allow for clearance as low as 1.6mm. Please refer to your local authorized retailer or your e-bike manufacturer for additional information about tire clearance.

Always maintain enough clearance between the rotating tire and rim (**fig. 26a & 26b**), and the frame, fork or other components. Regularly inspect the frame and fork for damage, as well as the area around the wheel for debris or objects that could become stuck.

When riding your e-bike, the tires must not be able to contact the fork, frame or any components when a suspension system is fully compressed or the wheels are subjected to flex from side loads. For example, with a suspension fork, the front tire must clear the fork crown when the fork is fully compressed.

WARNING: Inadequate tire clearance can allow debris or objects to become trapped or cause the wheels to stop unexpectedly, which could cause a crash resulting in serious injury or death.

WARNING: Inadequate tire clearance that results in contact between the tire and any part of the e-bike can result in damage which can lead to failure, which could cause a crash resulting in serious injury or death.

If you have mounted additional accessories or components on your e-bike, particularly fenders, these products may require additional clearance between the tire/wheel and the accessory or component. You should verify the required clearance for any accessory or component mounted on your e-bike with the manufacturer, and do not use the product if the specified clearance cannot be maintained. For additional information on changing components or adding accessories, see **Page 34, Section 7: “Safely Operating Your E-bike”, subsection L: “Changing Components or Adding Accessories”**.

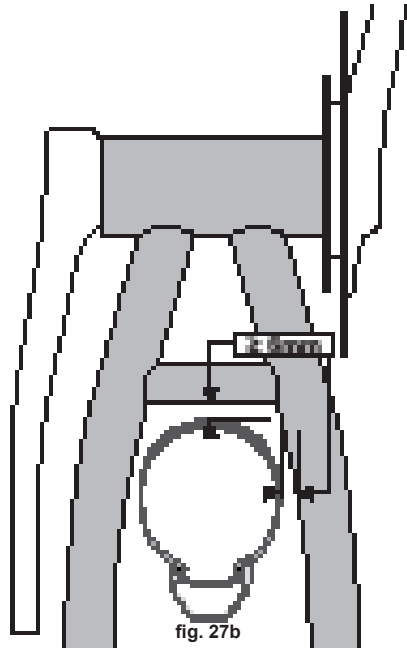

WARNING: Any accessory or component attached to, on or near a rotating wheel poses a risk of contacting or stopping the wheel, leading to a crash resulting in serious injury or death. Before every ride check to ensure that all such accessories and components, and the fasteners used to attach them, are securely mounted to your e-bike.

WARNING: Any object that unexpectedly and abruptly stops the rotation of the front wheel can cause the e-bike and rider to pitch forward (fig. 5), which can result in serious injury or death.

5. Tire valves

There are primarily two kinds of bicycle tire valves: The Schrader Valve and the Presta Valve. The bicycle pump you use must have the fitting appropriate to the valve stems on your e-bike.

The Schrader valve (**fig. 28a**) is like the valve on a car tire. To inflate a Schrader valve tire, remove the valve cap and clamp the pump fitting onto the end of the valve stem. To let air out of a Schrader valve, depress the pin in the end of the valve stem with the end of a key or other appropriate object.

The Presta valve (**fig. 28b**) has a narrower diameter and is only found on bicycle tires. To inflate a Presta valve tire using a Presta



headed bicycle pump, remove the valve cap; unscrew (counterclockwise) the valve stem lock nut; and push down on the valve stem to free it up. Then push the pump head on to the valve head, and inflate. To inflate a Presta valve with a Schrader pump fitting, you'll need a Presta adapter (available at your authorized retailer) which screws on to the valve stem once you've freed up the valve. The adapter fits into the Schrader pump fitting. Close the valve after inflation. To let air out of a Presta valve, open up the valve stem lock nut and depress the valve stem.

 **WARNING: We highly recommend that you carry a spare inner tube when you ride your e-bike. Patching a tube is an emergency repair. If you do not apply the patch correctly or apply several patches, the tube can fail, resulting in possible tube failure, which could cause you to lose control and fall. Replace a patched tube as soon as possible.**

12. Maintaining and Servicing Your E-bike

A. Servicing the Electrical Drive System

Your e-bike requires regular inspection, maintenance and service by a qualified technician to ensure the proper and safe function, performance and maximum life expectancy of your e-bike and its components. Exposure to road salt, rain, dirt or snow, can result in corrosion/deterioration of certain e-bike components. If any malfunctions or problems occur, or if you have any questions related to component installation, adjustment or maintenance, please refer to your authorized retailer for additional information.

Service to the drive system components (motor, battery, display(s), sensor(s), wiring, software/firmware updates) should always be performed by an authorized retailer. While it is recommended to have all service done by an authorized retailer, depending on mechanical competence and ease of required work, some service to non-drive-system-related components can be performed by the owner, with proper tools and knowledge. For example, the most basic services would include cleaning the e-bike or lubricating the chain. More involved services would include adjusting brakes or gears or fixing a flat tire that requires detaching electrical wiring or components.

 **WARNING: Modifying your e-bike or attempting to service it without having the requisite tools, skills and knowledge can result in damage to your e-bike or create a risk of fire or electrical shock resulting in serious injury or death.**

 **WARNING: The drive system does not contain any user-serviceable parts. Any service should be performed by a qualified technician. Do not attempt to open, disassemble, modify, adjust or service any parts of the drive system components. Any tampering with the internals of the motor, battery or other drive system components can result in damage, which can cause serious personal injury or death.**

Follow all service recommendations made by the manufacturer. Please refer to your authorized retailer for any questions about e-bike service intervals.

- Maintain your battery as outlined on **Page 3, Section 3: "General Lithium-Ion Battery Safety"** and **Page 10, Section 6: "E-bike Battery Safety"**.

- During periodic inspections, also inspect the battery terminals for any signs of corrosion. Also inspect any visible wiring. Frayed or otherwise damaged wires, loose or corroded plugs, or bad connections can result in damage to the drive system and should be inspected and replaced as necessary by your authorized retailer.
- Do not apply any cleaning agents, paint or chemicals to any of the drive system components on your e-bike, including the battery. Applying paint to these components can result in failure.
- Dirt and salt from riding in winter or near the ocean, as well as sweat, can be damaging to bicycle components. This includes e-bike drive system and wiring parts. Regularly keep the e-bike clean.
- When performing service on an e-bike, if possible, remove the battery before starting maintenance. If the battery is integrated into the frame and not easily removed, make sure the system is turned off unless absolutely necessary for a specific service, and make sure you're not at risk of injury should the system unexpectedly turn on and the drive system start rotating.
- Don't turn the e-bike upside down onto the handlebars and seat. This can result in damage to any handlebar-mounted display or controller components.



WARNING: Technological advances have made e-bikes and bicycle components more complex, and the pace of innovation is increasing. It is impossible for this manual to provide all the information required to properly repair and/or maintain your e-bike. In order to help minimize the chances of a crash and possible injury, it is critical that you have any repair or maintenance that is not specifically described in this manual performed by your authorized retailer. Equally important is that your individual maintenance requirements will be determined by everything from your riding style to geographic location. Consult your authorized retailer for help in determining your maintenance requirements.



WARNING: Many e-bike service and repair tasks require special knowledge and tools. Do not begin any adjustments or service on your e-bike until you have learned from your authorized retailer how to properly complete them. Improper adjustment or service may result in damage to the e-bike or in a crash which can cause serious injury or death.

B. Servicing the Mechanical Parts of Your E-bike

You may wish to service the mechanical (non-drive system and battery) parts of your e-bike yourself. If you want to learn to do minor service and repair work on your e-bike:

1. Ask your authorized retailer for the manufacturer's installation and service instructions for the components on your e-bike, or contact the component manufacturer.
2. Ask your authorized retailer to recommend a book on bicycle repair.
3. Ask your authorized retailer about the availability of bicycle repair courses in your area.

We recommend that you ask your authorized retailer to check the quality of your work the first time you work on something and before you ride the e-bike, just to make sure that you did everything correctly. Since that will require the time of a mechanic, there may be a modest charge for this service.

We also recommend that you ask your authorized retailer for guidance on what spare parts, such as tires, inner tubes, light bulbs, batteries, patch kit or lubricants it would be appropriate for you to have once you have learned how to replace such parts when they require replacement.

C. Service Intervals

Some service and maintenance of mechanical parts of an e-bike can and should be performed by the owner, and require no special tools or knowledge beyond what is presented in this manual.

The following are examples of the type of service you should perform yourself. All other service, maintenance and repair should be performed in a properly equipped facility by a qualified e-bike mechanic using the correct tools and procedures specified by the manufacturer.

1. Break-in Period: Your e-bike will last longer and work better if you break it in before riding it hard. Control cables and wheel spokes may stretch or “seat” when a new e-bike is first used and may require readjustment by your authorized retailer. Your Mechanical Safety Check will help you identify some things that need readjustment. Refer to **Page 22, Section 7: “Safely Operating Your E-bike”, subsection B: “Mechanical Safety Check”**. But even if everything seems fine to you, it’s best to take your e-bike back to your authorized retailer for a checkup. Authorized retailers typically suggest you bring the e-bike in for a 30-day checkup. Another way to judge when it’s time for the first checkup is to bring the e-bike in after three to five hours of hard off-road use, or about 10 to 15 hours of on-road or more casual off-road use. But if you think something is wrong with the e-bike, take it to your authorized retailer before riding it again.
2. Before every ride: Mechanical Safety Check (**Page 22, Section 7: “Safely Operating Your E-bike”, subsection B: “Mechanical Safety Check”**).
3. After every long or hard ride: if the e-bike has been exposed to water or grit; or at least every 100 miles: Clean the e-bike and lightly lubricate the chain’s rollers with a good-quality bicycle chain lubricant. Wipe off excess lubricant with a lint-free cloth. Lubrication is a function of climate. Talk to your authorized retailer about the best lubricants and the recommended lubrication frequency for your area.
4. After every long or hard ride or after every 10 to 20 hours of riding:
 - Squeeze the front brake and rock the e-bike forward and back. Everything feel solid? If you feel a clunk with each forward or backward movement of the e-bike, you probably have a loose headset. Have your authorized retailer check it.
 - Lift the front wheel off the ground and swing it from side to side. Feel smooth? If you feel any binding or roughness in the steering, you may have a tight headset. Have your authorized retailer check it.
 - Grab one pedal and rock it toward and away from the centerline of the e-bike; then do the same with the other pedal. Anything feel loose? If so, have your authorized retailer check it.
 - Take a look at the brake pads. Are they worn or not hitting the wheel rim squarely? Time to have your authorized retailer adjust or replace them.
 - Carefully check the control cables and cable housings. Any rust? Kinks? Fraying? If so, have your authorized retailer replace them.

- Squeeze each adjoining pair of spokes on either side of each wheel between your thumb and index finger. Do they all feel about the same? If any feel loose, have your authorized retailer check the wheel for tension and trueness.
 - Check the tires for excess wear, cuts or bruises. Have your authorized retailer replace them if necessary.
 - Check the wheel rims for excess wear, dings, dents and scratches. Consult your authorized retailer if you see any rim damage.
 - Check to make sure that all parts and accessories are still secure, and tighten any that are not.
 - Check the frame (particularly in the area around all tube joints), the handlebars, the stem and the seatpost for any deep scratches, cracks or discoloration. These are signs of stress-caused fatigue and indicate that a part is at the end of its useful life and needs to be replaced. See also Appendix B.
5. Disc brakes require a different set of inspection steps. Check for these issues before every ride:
- Pads rubbing on rotors.
 - Worn-out pads (which can lead to over-extended pistons).
 - Pistons that are stuck and/or won't retract fully.
 - Disc rotors that are bent and need straightening by your authorized retailer.
 - Hydraulic brakes that feel "sponge-y" and/or levers that can be depressed all the way to the grips without generating adequate stopping power (due to trapped air and/or leaks).



WARNING: Like any mechanical device, an e-bike and its components are subject to wear and stress. Different materials and mechanisms wear or fatigue from stress at different rates and have different life cycles. If a component's life cycle is exceeded, the component can suddenly and catastrophically fail, causing serious injury or death to the rider.

Scratches, cracks, fraying and discoloration are signs of stress-caused fatigue and indicate that a part is at the end of its useful life and needs to be replaced. While the materials and workmanship of your e-bike or of individual components may be covered by a warranty for a specified period of time by the manufacturer, this is no guarantee that the product will last the term of the warranty. Product life is often related to the kind of riding you do and to the treatment to which you submit the e-bike. The e-bike's warranty is not meant to suggest that the e-bike cannot be broken or will last forever. It only means that the e-bike is covered subject to the terms of the warranty. Please be sure to read Appendix A, Intended Use of your e-bike and Appendix B, The lifespan of your e-bike and its components, starting on page Page 73.

6. As required: If either brake lever fails the Mechanical Safety Check (**Page 22, Section 7: "Safely Operating Your E-bike", subsection B: "Mechanical Safety Check"**), don't ride the e-bike. Have your authorized retailer check the brakes. If the chain won't shift smoothly and quietly from gear to gear, the derailleur may be out of adjustment. See your authorized retailer.
7. Please refer to your authorized retailer for any questions about e-bike service intervals.

D. If Your E-bike Sustains an Impact

First, check yourself for injuries, and take care of them as best you can. Seek medical help if necessary.

Next, check your e-bike for damage.

After any crash, take your e-bike to your authorized retailer for a thorough check. Carbon composite components, including frames, wheels, handlebars, stems, cranksets or brakes which have sustained an impact must not be ridden until they have been disassembled and thoroughly inspected by a qualified mechanic.

See also Appendix B: “The Lifespan of your e-bike and its components”.



WARNING: A crash or other impact can put extraordinary stress on bicycle components, causing them to fatigue prematurely.

Components suffering from stress fatigue can fail suddenly and catastrophically, causing loss of control, serious injury or death.

Appendix A: The Lifespan of Your Bike and its Components

1. Nothing Lasts Forever, Including Your E-Bike.

When the useful life of your e-bike or its components is over, continued use is hazardous.

Every e-bike and its component parts have a finite, limited useful life. The length of that life will vary with the construction and materials used in the frame and components; the maintenance and care the frame and components receive over their life; and the type and amount of use to which the frame and components are subjected. Use in competitive events, trick riding, ramp riding, jumping, aggressive riding, riding on severe terrain, riding in severe climates, riding with heavy loads, commercial activities and other types of non-standard use can dramatically shorten the life of the frame and components. Any one or a combination of these conditions may result in an unpredictable failure.

All aspects of use being identical, lighter e-bikes and their components will usually have a shorter life than heavier e-bikes and their components. In selecting a lightweight e-bike or components you are making a tradeoff, favoring the higher performance that comes with lighter weight over longevity. So, If you choose lightweight, high-performance equipment, be sure to have it inspected frequently. You should have your e-bike and its components checked periodically by your authorized retailer for indicators of stress and/or potential failure, including cracks, deformation, corrosion, paint peeling, dents, and any other indicators of potential problems, inappropriate use or abuse. These are important safety checks and very important to help prevent crashes, bodily injury to the rider and shortened product life.

2. Perspective

Today's high-performance e-bikes require frequent and careful inspection and service. In this Appendix we try to explain some underlying material science basics and how they relate to your e-bike. We discuss some of the trade-offs made in designing your e-bike and what you can expect from your e-bike; and we provide important, basic guidelines on how to maintain and inspect it. We cannot teach you everything you need to know to properly inspect and service your e-bike; and that is why we repeatedly urge you to take your e-bike to your authorized retailer for professional care and attention.

 **Frequent inspection of your e-bike is important to your safety. Follow the Mechanical Safety Check on Page 22, Section 7: "Safely Operating Your E-bike", subsection B: "Mechanical Safety Check" of this Manual before every ride.**

Periodic, more detailed inspection of your e-bike is important. How often this more detailed inspection is needed depends upon you.

You, the rider/owner, have control and knowledge of how often you use your e-bike, how hard you use it and where you use it. Because your authorized retailer cannot track your use, you must take responsibility for periodically bringing your e-bike to your authorized retailer for inspection

and service. Your authorized retailer will help you decide what frequency of inspection and service is appropriate for how and where you use your e-bike.

For your safety, understanding and communication with your authorized retailer, we urge you to read this Appendix in its entirety. The materials used to make your e-bike determine how and how frequently to inspect.

Ignoring this WARNING can lead to frame, fork or other component failure, which can result in serious injury or death.

A. Understanding metals

Steel is the traditional material for building bicycle frames. It has good characteristics, but in high-performance e-bikes, steel has been largely replaced by aluminum and in some cases by carbon fiber or titanium. The main factor driving this change is interest in lighter e-bikes by cycling enthusiasts.

Properties of Metals

Please understand that there is no simple statement that can be made that characterizes the use of different metals for e-bikes. What is true is how the metal chosen is applied is much more important than the material alone. One must look at the way the e-bike is designed, tested, manufactured and supported along with the characteristics of the metal rather than seeking a simplistic answer.

Metals vary widely in their resistance to corrosion. Steel must be protected or rust will attack it. Aluminum and Titanium quickly develop an oxide film that protects the metal from further corrosion. Both are therefore quite resistant to corrosion. Aluminum is not perfectly corrosion resistant, and particular care must be used where it contacts other metals and galvanic corrosion can occur.

Metals are comparatively ductile. Ductile means bending, buckling and stretching before breaking. Generally speaking, of the common e-bike frame building materials steel is the most ductile, titanium less ductile, followed by aluminum.

Metals vary in density. Density is weight per unit of material. Steel weighs 7.8 grams/cm³ (grams per cubic centimeter), titanium 4.5 grams/cm³, aluminum 2.75 grams/cm³. Contrast these numbers with carbon fiber composite at 1.45 grams/cm³.

Metals are subject to fatigue. With enough cycles of use, at high enough loads, metals will eventually develop cracks that lead to failure. It is very important that you read the basics of metal fatigue below.

Let's say you hit a curb, ditch, rock, car, another cyclist or other object. At any speed above a fast walk, your body will continue to move forward, momentum carrying you over the front of the e-bike. You cannot and will not stay on the e-bike, and what happens to the frame, fork and other components is irrelevant to what happens to your body.

What should you expect from your metal frame? It depends on many complex factors, which is why we tell you that crashworthiness cannot be a design criteria. With that important note, we can tell you that if the impact is hard enough the fork or frame may be bent or buckled. On a steel e-bike, the steel fork may be severely bent and the frame undamaged. Aluminum is less ductile than steel, but you can expect the fork and frame to be bent or buckled. Hit harder and the top tube may be broken in tension and the down tube buckled. Hit harder and the top tube may be broken, the down tube buckled and broken, leaving the head tube and fork separated from the main triangle.

When a metal e-bike crashes, you will usually see some evidence of this ductility in bent, buckled or folded metal.

It is now common for the main frame to be made of metal and the fork of carbon fiber. See **Page 76, “Appendix B: The Lifespan of Your Bike and its Components”, subsection B: “Understanding composites”** below. The relative ductility of metals and the lack of ductility of carbon fiber means that in a crash scenario you can expect some bending or bucking in the metal but none in the carbon. Below some load the carbon fork may be intact even though the frame is damaged. Above some load the carbon fork will be completely broken.

The Basics of Metal Fatigue

Common sense tells us that nothing that is used lasts forever. The more you use something, and the harder you use it, and the worse the conditions you use it in, the shorter its life.

Fatigue is the term used to describe accumulated damage to a part caused by repeated loading. To cause fatigue damage, the load the part receives must be great enough. A crude, often-used example is bending a paper clip back and forth (repeated loading) until it breaks. This simple definition will help you understand that fatigue has nothing to do with time or age. An e-bike in a garage does not fatigue. Fatigue happens only through use.

So what kind of “damage” are we talking about? On a microscopic level, a crack forms in a highly stressed area. As the load is repeatedly applied, the crack grows. At some point the crack becomes visible to the naked eye. Eventually it becomes so large that the part is too weak to carry the load that it could carry without the crack. At that point there can be a complete and immediate failure of the part.

One can design a part that is so strong that fatigue life is nearly infinite. This requires a lot of material and a lot of weight. Any structure that must be light and strong will have a finite fatigue life. Aircraft, race cars and motorcycles all have parts with finite fatigue lives. If you wanted an e-bike with an infinite fatigue life, it would weigh far more than any e-bike sold today. So we all make a tradeoff: the wonderful, lightweight performance we want requires that we inspect the structure.

What to Look For

<ul style="list-style-type: none"> • ONCE A CRACKS STARTS IT CAN GROW AND GROW FAST. Think about the crack as forming a pathway to failure. This means that any crack is potentially dangerous and will only become more dangerous. 	<p>SIMPLE RULE 1 : If you find a crack, replace the part.</p>
<ul style="list-style-type: none"> • CORROSION SPEEDS DAMAGE. Cracks grow more quickly when they are in a corrosive environment. Think about the corrosive solution as further weakening and extending the crack. 	<p>SIMPLE RULE 2 : Clean your e-bike, lubricate your e-bike, protect your e-bike from salt, remove any salt as soon as you can.</p>
<ul style="list-style-type: none"> • STAINS AND DISCOLORATION CAN OCCUR NEAR A CRACK. Such staining may be a warning sign that a crack exists. 	<p>SIMPLE RULE 3 : Inspect and investigate any staining to see if it is associated with a crack.</p>
<ul style="list-style-type: none"> • SIGNIFICANT SCRATCHES, GOUGES, DENTS OR SCORING CREATE STARTING POINTS FOR CRACKS. Think about the cut surface as a focal point for stress (in fact engineers call such areas “stress risers,” areas where the stress is increased). Perhaps you have seen glass cut? Recall how the glass was scored and then broke on the scored line. 	<p>SIMPLE RULE 4 : Do not scratch, gouge or score any surface. If you do, pay frequent attention to this area or replace the part.</p>

• SOME CRACKS (particularly larger ones) MAY MAKE A CREAKING NOISE AS YOU RIDE. Think about such a noise as a serious warning signal. Note that a well-maintained e-bike will be very quiet and free of creaks and squeaks.

SIMPLE RULE 5 : Investigate and find the source of any noise. It may not be a crack, but whatever is causing the noise should be fixed promptly.

Fatigue Is Not A Perfectly Predictable Science

Fatigue is not a perfectly predictable science, but here are some general factors to help you and your authorized retailer determine how often your e-bike should be inspected. The more you fit the “shorten product life” profile, the more frequent your need to inspect. The more you fit the “lengthen product life” profile, the less frequent your need to inspect.

Factors that shorten product life:

- **Hard, harsh riding style**
- **“Hits”, crashes, jumps, other “shots” to the e-bike**
- **High mileage**
- **Higher body weight**
- **Stronger, more fit, more aggressive rider**
- **Corrosive environment (wet, salt air, winter road salt, accumulated sweat)**
- **Presence of abrasive mud, dirt, sand, soil in riding environment**

Factors that lengthen product life:

- **Smooth, fluid riding style**
- **No “hits”, crashes, jumps, other “shots” to the e-bike**
- **Low mileage**
- **Lower body weight**
- **Less aggressive rider**
- **Non-corrosive environment (dry, salt-free air)**
- **Clean riding environment**



WARNING: Do not ride an e-bike or component with any crack, bulge or dent, even a small one. Riding a cracked frame, fork or component could lead to complete failure, with risk of serious injury or death.

B. Understanding composites

All riders must understand a fundamental reality of composites. Composite materials constructed of carbon fibers are strong and light, but when crashed or overloaded, carbon fibers do not bend, they break.

What Are Composites?

The term “composites” refers to the fact that a part or parts are made up of different components or materials. You’ve heard the term “carbon fiber e-bike.” This really means “composite e-bike.”

Carbon fiber composites are typically a strong, light fiber in a matrix of plastic, molded to form a shape. Carbon composites are light relative to metals. Steel weighs 7.8 grams/cm³ (grams per cubic centimeter), titanium 4.5 grams/cm³, aluminum 2.75 grams/cm³. Contrast these numbers with carbon fiber

composite at 1.45 grams/cm³.

The composites with the best strength-to-weight ratios are made of carbon fiber in a matrix of epoxy plastic. The epoxy matrix bonds the carbon fibers together, transfers load to other fibers, and provides a smooth outer surface. The carbon fibers are the “skeleton” that carries the load.

Why Are Composites Used?

Unlike metals, which have uniform properties in all directions (engineers call this isotropic), carbon fibers can be placed in specific orientations to optimize the structure for particular loads. The choice of where to place the carbon fibers gives engineers a powerful tool to create strong, light e-bikes. Engineers may also orient fibers to suit other goals such as comfort and vibration damping.

Carbon fiber composites are very corrosion resistant, much more so than most metals. Think about carbon fiber or fiberglass boats.

Carbon fiber materials have a very high strength-to-weight ratio.

What Are The Limits Of Composites?

Well designed “composite” or carbon fiber e-bikes and components have long fatigue lives, usually better than their metal equivalents.

While fatigue life is an advantage of carbon fiber, you must still regularly inspect your carbon fiber frame, fork or components.

Carbon fiber composites are not ductile. Once a carbon structure is overloaded, it will not bend; it will break. At and near the break, there will be rough, sharp edges and maybe delamination of carbon fiber or carbon fiber fabric layers. There will be no bending, buckling or stretching.

If You Hit Something Or Have A Crash, What Can You Expect From Your Carbon Fiber E-bike?

Let’s say you hit a curb, ditch, rock, car, other cyclist or other object. At any speed above a fast walk, your body will continue to move forward, the momentum carrying you over the front of the e-bike. You cannot and will not stay on the e-bike and what happens to the frame, fork and other components is irrelevant to what happens to your body.

What should you expect from your carbon frame? It depends on many complex factors. But we can tell you that if the impact is hard enough, the fork or frame may be completely broken. Note the significant difference in behavior between carbon and metal. See **Page 74, “Appendix B: The Lifespan of Your Bike and its Components”, subsection A: “Understanding metals”**. Even if the carbon frame was twice as strong as a metal frame, once the carbon frame is overloaded it will not bend, it will break completely.



WARNING: Be aware that high temperature in a confined environment can affect the integrity of composite materials, resulting in component failure which could cause you to lose control and fall.

Inspection of Composite Frame, Fork and Components

Cracks:

Inspect for cracks, broken or splintered areas. Any crack is serious. Do not ride any e-bike or component that has a crack of any size.

Delamination:

- Delamination is serious damage. Composites are made from layers of fabric. Delamination means that the layers of fabric are no longer bonded together. Do not ride any e-bike or component that has any delamination. These are some delamination clues:
- A cloudy or white area. This kind of area looks different from the ordinary undamaged areas. Undamaged areas will look glassy, shiny, or “deep,” as if one was looking into a clear liquid. Delaminated areas will look opaque and cloudy.
- Bulging or deformed shape. If delamination occurs, the surface shape may change. The surface may have a bump, a bulge, soft spot, or not be smooth and fair.
- A difference in sound when tapping the surface. If you gently tap the surface of an undamaged composite you will hear a consistent sound, usually a hard, sharp sound. If you then tap a delaminated area, you will hear a different sound, usually duller, less sharp.

Unusual Noises:

Either a crack or delamination can cause creaking noises while riding. Think about such a noise as a serious warning signal. A well maintained e-bike will be very quiet and free of creaks and squeaks. Investigate and find the source of any noise. It may not be a crack or delamination, but whatever is causing the noise must be fixed or replaced before riding.



WARNING: Do not ride an e-bike or component with any delamination or crack. Riding a delaminated or cracked frame, fork or other component could lead to complete failure, with risk of serious injury or death.

C. Understanding components

It is often necessary to remove and disassemble components in order to properly and carefully inspect them. This is a job for a professional e-bike mechanic with the special tools, skills and experience to inspect and service today’s high-tech high-performance e-bikes and their components.

Aftermarket “Super Light” Components

Think carefully about your rider profile as outlined above. The more you fit the “shorten product life” profile, the more you must question the use of super light components. The more you fit the “lengthen product life” profile, the more likely it is that lighter components may be suitable for you. Discuss your needs and your profile very honestly with your authorized retailer.

Take these choices seriously and understand that you are responsible for the changes.

A useful slogan to discuss with your authorized retailer if you contemplate changing components is “Strong, Light, Cheap — pick two.”

Original Equipment Components

E-bike and component manufacturers test the fatigue life of the components that are original equipment on your e-bike. This means that they have met test criteria and have reasonable fatigue life. It does not mean that the original components will last forever. They won’t.

Appendix B: Fastener Torque Specifications

Correct tightening torque of threaded fasteners is very important to your safety. Always tighten fasteners to the correct torque. In case of a conflict between the instructions in this manual and information provided by a component manufacturer, consult with your authorized retailer or the manufacturer's customer service representative for clarification. Bolts that are too tight can stretch and deform. Bolts that are too loose can move and fatigue. Either mistake can lead to a sudden failure of the bolt.

Always use a correctly calibrated torque wrench to tighten critical fasteners on your e-bike. Carefully follow the torque wrench manufacturer's instructions on the correct way to set and use the torque wrench for accurate results.

RECOMMENDED TIGHTENING VALUES - TORQUE VALUES

FRAME AND FORK			
COMPONENT	LBF.IN	NEWTON METERS (NM)	KGf.CM
Kickstand Mounting Bolts	26.7-53.4	3-6	30.6-61.2
Water Bottle Mounting Bolts	25-35	2.8-4	29-40
Fender Bolts	50-60	5.6-6.8	58-69

BRAKES			
COMPONENT	LBF.IN	NEWTON METERS (NM)	KGf.CM
Brake Lever	53-60	6-6.8	61-69
Centerlock Rotor Lockring	350-435	40-50	408-510
Caliper Mount	55-70	6.2-7.9	63-81

WHEELS			
COMPONENT	LBF.IN	NEWTON METERS (NM)	KGf.CM
Free Hub Body	305-434	34.5-49	352-499
Cassette Sprocket Lockring	260-434	29.4-49	299-499
Front Thru-Axle	89-133.5	10-15	102-153
Rear Axle Nut	89	10	102

DRIVETRAIN			
COMPONENT	LBF.IN	NEWTON METERS (NM)	KGf.CM
Pedal into Crank	307	34.7	353
Crank Bolt	6.23-13.35	0.7 - 1.5	7.14-15.3

OTHER			
COMPONENT	LBF.IN	NEWTON METERS (NM)	KGf.CM
Steerer Clamp Bolt (Stem)	70-89	8-10	80-102
Top Cap Bolt	35-53	4-6	41-62
Handlebar Clamp Bolts (4 Bolts)	36-53	4-6	41.62
Saddle Rail Clamp	70-89	8-10	80-102

Relationship : 1 Nm = 8.9 lbf.in = 10.2 kgf.cm

Appendix C: Xtracycle Passenger and Cargo Transit

Carrying cargo and kids while riding changes the handling, balance, and weight of your Xtracycle. For your safety, please read the guidelines below.

HANDLING CHANGES:

A combination of factors – including the frame rigidity, component strength, and weight distribution – affect the bike’s handling. When riding with a heavy load, the bicycle will require more effort to balance and more time to brake.

There is a strong relationship between the weight of the rider and the amount of cargo the rider can comfortably balance and ride with.

In practice, cargo weight should be no more than 80% of the rider’s weight. Get familiar with riding a loaded bicycle in a location away from traffic and pedestrians before riding on public roads.

WARNING: DO NOT EXCEED THE MAXIMUM CARRYING CAPACITY, WHICH INCLUDES RIDER WEIGHT, PASSENGER WEIGHT, REAR RACK, CHILD SEAT(S) AND ANY OTHER ACCESSORIES. CHECK THE SAFETY FRAME STICKER ON THE BICYCLE FRAME FOR THE MAXIMUM WEIGHT LIMIT.

RIDING WITH CHILDREN:

You may install and use a child seat provided that your seat and setup meet the following requirements:

- The seat, WheelSkirt, or FreeLoader Too are designed so that any contact between the child’s feet and the wheel is impossible.
- The child’s fingers are protected against being caught in any part of the Saddle (such as the springs of suspension saddles).
- The carrier (rack) is approved for mounting child seats. Xtracycle-designed racks are approved for mounting child safety seats. Please either purchase an approved seat from Xtracycle, or consult Xtracycle to learn about the available approved seats.

As a general guideline, a single Child Seat should be mounted as far forward as possible for keeping the weight centralized. When using two Child Seats, space them evenly with the heavier child up front. always check the balance thoroughly. Mount the Child Seat and load with dummy weight equivalent to that of the child.

Test ride in various road conditions including riding uphill and make sure you are comfortable riding with the weight of a child.



WARNING: THE CHILD SEAT SHOULD NOT BE MOUNTED OR ATTACHED TO THE SEATPOST. MAKE SURE TO ATTACH THE SEAT FIRMLY TO THE DECK AND USE THE SAFETY STRAP FOR EXTRA SECURITY.

APPROVED CHILD SEATS:

Please either purchase an approved seat from Xtracycle, or consult Xtracycle to learn about the available approved seats.

SAFETY AND PRECAUTIONS:

- Children – regardless of age – should be strong enough to hold up their head and withstand the bouncing that comes with riding.
- Check for sufficient heel clearance. Heel clearance varies with the rider's foot size and the child's leg length.
- Make sure the seat is properly mounted in accordance with the manufacturer's instructions.
- Make sure the maximum gross weight is not exceeded for your Xtracycle.
- Make sure that nothing can get caught in the Wheel Spokes, Saddle Rails, and Springs.
- Make sure the child is wearing a helmet and the straps are adjusted for a snug fit.
- Always hold onto your bike when a child is in the child seat to prevent the bike and child from falling over.
- Use the KickBack or Kickstand to stabilize the bike when not in motion.
- Periodically check on your child while riding as they may fall asleep. Don't let their head strain excessively to one side.

CARRYING PASSENGERS:

An Xtracycle is designed to carry an adult passenger if the passenger can straddle the bicycle and properly rest their feet on the RFA FootPegs, RFA Footsies, or U-Tubes. We also require the use of an WheelSkirt or FreeLoader Too bag to cover the rear wheel whenever passengers are on the bike.



WARNING: WE ALWAYS REQUIRE USE OF WHEELCOVERS WITH OUR BIKES TO PROTECT PASSENGERS FEET. FAILURE TO DO SO COULD RESULT IN INJURY.

FOOTREST:

The RFA FootPegs, RFA Footsies, or U-Tubes are designed for a passenger to safely rest their feet on while riding.

KICKSTAND AND PARKED WEIGHT:

The bicycles comes equipped with a KickBack. Always deploy the KickBack when the bike is not in use to stabilize the bike, cargo, and passengers. Make sure to stabilize all loads on your bike before disengaging the kickstand.

Do not apply excessive downward force on the bike while the kickstand is engaged to avoid damaging the kickstand or kickstand mounting area on your bike.

CARGO POSITIONING:

Position cargo so that the center of gravity is as close to the centerline of the bicycle as possible. Secure the cargo as close to the front of the rack as possible. Balance the load. For example, when carrying a box, you should try to carry two if possible (one on either side). Lopsided loads can pull the bicycle to one side.

SECURING CARGO:

Make sure your cargo is secured well to avoid losing cargo when you are riding.

INTERFERENCE CHECK:

- Make sure that you have enough space to sit properly, pedal, and steer the bike without any interference.
- Cargo should not interfere with normal operations of the brakes and derailleur(s).
- Long or large objects should be positioned far enough from the pedals to avoid heel strikes.
- Tall or large objects in the front of the bike should not block your vision.

 **WARNING: IF YOU ARE UNABLE TO FULFILL ANY OF THE ABOVE CONDITIONS OR UNABLE TO FOLLOW ANY OF THE INSTRUCTIONS ABOVE, PLEASE DO NOT CARRY PASSENGERS OR CARGO ON YOUR XTRACYCLE.**

Appendix D: Warranty

XTRACYCLE LIMITED WARRANTY:

The Xtracycle warranty covers each steel made frame and fork of the bicycle or e-bike against defects in manufacturing and materials for the lifetime of the bike for the original owner for personal use.

Aluminum frames and suspension forks are covered for five (5) years against defects in manufacturing and materials for the original owner for personal use.

Commercial use warranty is valid for one (1) year for the original owner for commercial use only, regardless of frame/fork material.

If your warranty claim for a bike or e-bike is approved, Xtracycle will do one of the following at its discretion:

- Provide you a replacement frame or fork OR
- Give you a store credit at xtracycle.com for the value of your frame or fork.

All Xtracycle original parts are covered for a period of one (1) year for personal use or six (6) months for commercial use, except for the parts listed which are not warrantied once the bike or e-bike is ridden or are not a part manufactured by Xtracycle: bar-end plugs, brake pads, chain, chain guard, cassette, chainrings, grips, handlebar stabilizing spring, kickstand ends, nipples, spokes, rims, tires, tubes, and valves, front and rear brake caliper and pads, front and rear brake rotor, brake levers, headset, handlebar grips, shifter, front and rear derailleur, crank, cassette, front and rear hub, front and rear tire and inner tube, pedals, Shimano parts, charger, display, chain.

LIMITED WARRANTY: XTRACYCLE ACCESSORIES

This warranty does not cover: normal wear and tear, improper assembly, improper follow-up maintenance, installation of parts or accessories not originally intended for, or compatible with, the bicycle as sold; damage or failure due to accident, misuse, abuse, or neglect, labor charges for part replacement or changeover, original shipping costs. Xtracycle warrants each Xtracycle accessory against defects in workmanship and materials for one (1) year.

CA.USA
xtracycle
SINCE 1998



Questions? Contact us anytime:

Email: support@xtracycle.com | Phone/Text: 888-537-1401

Xtracycle (Priority Outdoor Products, LLC), 237 Shoreline Hwy, Mill Valley, CA 94941