

2x2 Electric Adventure Motorbike

**USER MANUAL - United States
MODEL: 2x2 SE 2023**

UBCO

Welcome to your 2023 Special Edition 2x2

Congratulations on your uniquely numbered, limited edition bike.

For the 2023 Special Edition, our product design team has created a fresh twist on the classic 2x2 Adventure bike. The Special Edition has been designed to intertwine both outdoor and urban worlds, catering to the everyday adventurer. Accessorized, ready to go, and carefully crafted to provide a comfortable, yet tough and durable riding experience, whether you're running essential errands or tackling the great outdoors. Enjoy.

2x2 SE User Manual

SPECIAL EDITION MODEL 2023

CONTENTS

1. INTRODUCTION	3
2. ASSEMBLY	4
3. TECHNICAL INFORMATION	8
4. YOUR KEYS	10
5. HANDLEBAR CONTROLS	12
6. LCD DISPLAY	15
7. ADJUSTABLE SUSPENSION	17
8. ACCESSORY LUGS	20
9. YOUR BATTERY	21
10. RIDING SAFETY	25
11. LOADING THE 2x2	28
12. ALERT CODES	30
13. FAQ	32
14. MAINTENANCE	34
15. LIMITED WARRANTY	38

1. INTRODUCTION

First things first:

Register your information at www.ubco.com/register

This ensures we know about your purchase; registration is required for any future warranty claims. Keep your receipt of purchase somewhere safe, such as stapled to this manual, and record your VIN, which is engraved on the right-hand side of the frame head tube.

Next:

Scan this code with your smartphone to download the UBCO App. Keep the app updated and it will keep your bike up to date.



Enable Bluetooth and location services on your phone and ensure your 2x2 is turned on and in range before opening the app.

Then:

Read this manual carefully. Pay special attention to the safety messages that appear throughout. This manual should be considered a permanent part of the 2x2 and should remain with your bike if resold.



IMPORTANT: When you see this symbol, the information following is important for safety and proper function of the 2x2. Please take care to read text with this warning.

2. ASSEMBLY

Before You Start

Under your seat in the Field Kit, you'll find all the tools to assemble your 2X2. Feel free to contact us for help assembling the bike or scan the QR code to watch our "How to" video.



2.1 Align the handlebars

Loosen the side bolts on the stem with a 5mm Allen key. Straighten the handlebars perpendicular to the front wheel.

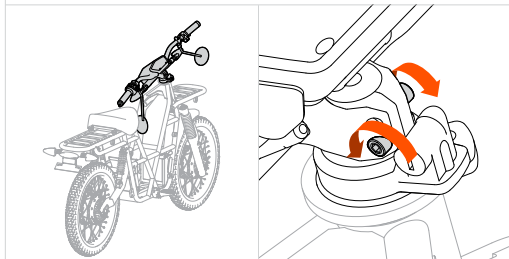

Once the handlebars are straight, retighten the stem bolts, alternating as you go to prevent damage to the clamp. Align the marking on the bolt head to achieve the correct tightness. Torque to 15Nm, if a torque wrench is available.

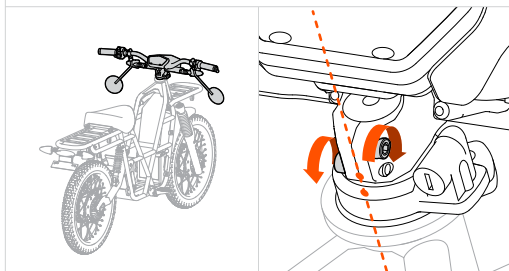

2.2 Fit the rear indicators

Unpack the rear indicator lights. Install indicators to their respective side on the rear light bracket. Check the orientation – the indicator with a long cable is fitted to left side, the short cable goes to right side.

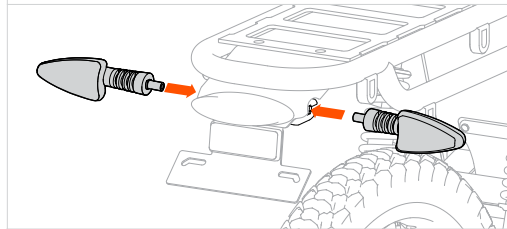

Insert the thread through the mount, ensuring the nut and two washers are on the inside. Lights should face straight back. Use a 17mm spanner to tighten the fastening nuts.

2.3 Fit the mirrors

Remove the mirrors from their box. Screw the base of the mirror arm clockwise into the handlebar mount approximately 10mm and into the correct position, but do not tighten.

Using a 14mm spanner, tighten the locking nut to secure the mirror arm. Slide down the rubber booty. Repeat for the other mirror. Adjust the mirror angle from a sitting position to provide maximum visibility.

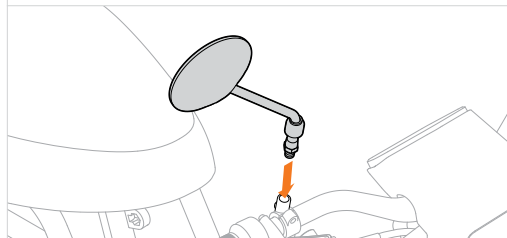

2.4 Install the battery

IMPORTANT: Inspect the battery; contact UBCO if there is any damage from transit.

If the battery is not already in place, remove the battery strap from the frame and set aside. With the power socket on the right-hand side of the bike, carefully lower the battery into place with two hands.

Plug the bike power plug (B) into the battery power socket (A) and use the securing key to lock the battery in place (C).

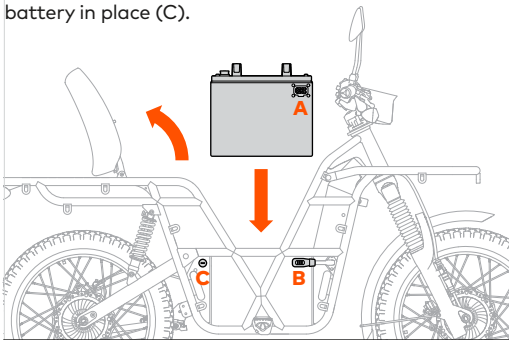

2.5 Secure the battery strap

Velcro side down, tuck the end of the battery strap under the left hand bar, central to the battery. Carry the strap over the battery and tuck it under the right hand bar. Feed the strap back through the clip and center the clip. Tighten the strap and secure closed.

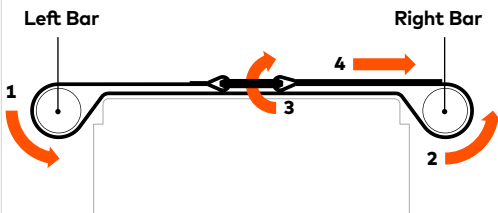

2.6 Pre-Ride Checklist



DO NOT ride the bike if it is materially defective, damaged, or missing safety-related equipment. Physically check each of these items before you ride.

1. Battery

Ensure there is enough charge to carry out your work or journey. Check that the battery strap is secured tightly.

2. Brakes

Check the brakes are working and inspect their brake pads for wear.

3. Lights

Ensure the headlights, rear light, brake light, and turn signals are working.

4. Kickstand

Check the kickstand is functional, especially if the bike is loaded up, and check it stays up when retracted. Retract the kickstand before riding.

5. Mirrors

Check they are properly fastened and adjusted for proper viewing.

6. Horn

Sound the horn to ensure it's working.

7. Tires

Check the condition and pressure of the tires.

8. Loose Fixings

Ensure all the fixings (nuts & bolts) are done up correctly and securely.

9. Load

Ensure all functional parts of the bike are not obstructed by any load you may be carrying.

10. Safety Wear

For your safety, please wear a helmet and appropriate riding gear.

11. Keys

Remember to take your key fob with you (unless you've turned security mode off).

3. TECHNICAL INFORMATION

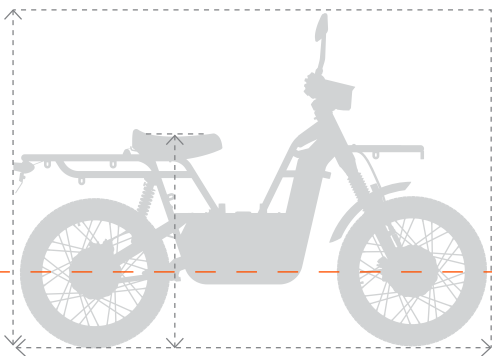

Max Submersion Depth

Do not submerge the 2x2 in water above the axles. This could damage the motors and void the warranty.

SPECIFICATIONS	METRICS	IMPERIAL
Drive Train	2 x 1kW motors	
Weight (ex Battery)	52.7kg	116lbs
Height	1,040mm	41in
Seat Height	830mm	32.6in
Width (Handlebars)	820mm	32.3in
Length	1,820mm	72in
Wheelbase	1,215mm	47.8in
Payload (incl Rider)	150kg	330lbs
Suspension - Front	130mm adjustable	5.12in
Suspension - Rear	120mm adjustable	4.72in
Range (Max Tested ¹)	120km	75mi
Max Speed	50km/h (EU 45km/h limited)	30mph
Charge time 0-100%	4-6hr	
LED Headlight	High: 2,100lm; Low: 1,200lm	

NZ:	LA (Moped)
AU:	LA (Moped)
US:	Dependent on state laws.
EU:	L1e-B
UK:	L1e-B

LICENSE REQUIREMENTS²

NZ:	Learner license or higher.
AU:	State dependent; provisional or motorcycle license.
US:	Dependent on state laws.
EU:	Dependent on country laws.
UK:	Category AM, CBT required.

¹ Real-life variables such as speed, drive settings, weight, and terrain will impact range.

² Laws vary by region. Check your local licensing laws to determine license requirements.

All information in this publication is based on the latest production information available at the time of approval for printing. UBCO Ltd reserves the right to make changes at any time without notice.

4. YOUR KEYS

The 2X2 comes with two types of keys: a key fob and a securing key. The key fob is used to turn the bike on or off, while the securing key activates the steering lock and the battery lock.

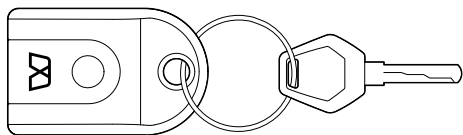

4.1 Powering the Bike

The key fob will turn the 2X2 on but the kill switch is used to change between Neutral and Drive.

Neutral: The screen will turn on, throttle is inactive.

Drive: Throttle is activated and the lights turn on.

- Hold the key fob button 1.5 seconds to turn the bike on in Neutral. The display will turn on and N is illuminated.
- If you're ready to ride, straddle the bike and retract the kickstand, then press the kill switch to enable Drive. The headlight will turn on.
- Twist the throttle towards you to go.
- Once stopped, press the kill switch to turn the bike back to Neutral. To turn bike off from Neutral, hold the key fob button for 1 second or hold the kill switch for 2 seconds.
- To turn bike off from Drive, press either the key fob button or the kill switch button for 2 seconds.

⚠ The 2X2 is very quiet due to its electric motors and **will not rev** when it is turned to Drive or when the throttle is turned.

4.2 Steering Security Lock

The 2X2 has a steering lock on the head tube, which will fix the steering angle of the parked bike. This makes the 2X2 difficult to wheel away as it will only turn in circles.

The steering lock is located on the right side of the steering tube just below the handlebars.

Use the securing key to activate/deactivate the steering lock:

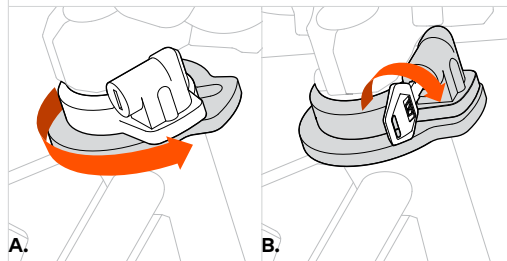

⚠ It is important to ensure the **steering lock is disengaged** and the securing key is removed before starting the 2X2.

- Turn the handlebars counter-clockwise (to the left) until the lock body lines up with the securing ring on the head tube.
- Put the securing key in and turn clockwise to lock.
- Unlock the steering by turning the key counter-clockwise; use the steering as per normal.

The same key can be used to lock the battery in place.

5. HANDLEBAR CONTROLS

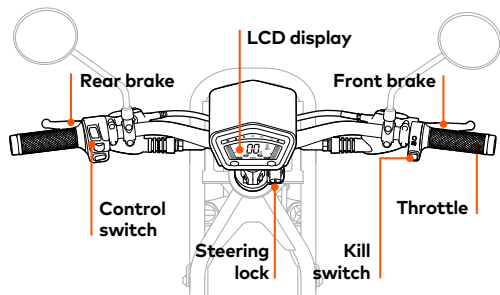

5.1 Control Switch

On the left side of the handlebar you will find a control switch with buttons for the headlight, indicators, & horn.

The headlight and tail lights automatically come on when the 2x2 is in Drive. To turn off the headlight, either switch to Neutral using the key fob or kill switch, open settings in the UBCO Rider's App and turn lights off, or hold the low beam switch until it turns off (repeat to turn back on).

Holding the high beam switch will activate the headlight in Neutral for when temporary lighting is required while the throttle is inactive. Do not use the high beam against oncoming traffic.

5.2 Kill Switch

On the right side of the handlebar, next to the throttle, is the kill switch for the motors. When the kill switch is activated, the bike will change to Neutral and N shows on the LCD display.

To switch into Drive, retract the kickstand and press the kill switch to deactivate it.

5.3 Security Mode

Security Mode determines whether the key fob is required to turn the bike on.

Security Mode ON: The key fob is required to turn the bike on.

Security Mode OFF: Enables the bike to be powered without the key fob; the bike is turned on using the kill switch.

To turn security mode on or off, follow the steps below. (Note, this process can only be performed using a fob that is already paired to the bike.)

1. Turn off the bike. Press and hold both the key fob button and the kill switch for 10 seconds.
2. The bike will beep a few times while the buttons are held and then give one final long beep to indicate programming is complete.



Turning off **Security Mode** will allow anyone with access to the bike to turn it on and use it.

5.4 Phone Mount

The bike comes fitted with a Peak Design phone mount featuring vibration isolation to protect your phone and magnetic locking technology to enable one-handed phone attachment and removal.

Simply attach the Universal Adapter to your phone case following the instructions provided or use a compatible Peak Design phone case. Then, to attach your phone, simply hold the back of your phone over the mount and it will click into place. Press one of the tabs on either side to release your phone.

5.5 Throttle

To accelerate, twist the throttle towards you. There are no gears or clutch, so the throttle controls all acceleration from start to top speed (excluding gravity). To maintain a constant speed, hold the throttle in a constant position. If you let go of the throttle, the 2x2 will start to decelerate.

Note: Do not continuously power the throttle when the 2x2 is held stationary.

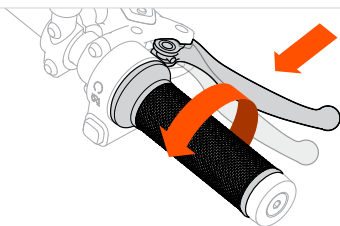

5.6 Brakes

Bedding in the brakes: For optimum brake performance with new bikes or brake pads, we recommend performing a series of 10 sequential firm braking efforts from 40kph / 25mph to 5kph / 3mph in a controlled environment. This will ensure that the brake pad material is sufficiently deposited onto the rotor, improving the total braking force available, as well as resistance to overheating.

Regenerative braking system: To slow down, release the throttle to neutral position and then apply the brakes: left = rear, right = front. The UBCO drive system incorporates a progressive regenerative braking system, where the motors themselves apply controlled braking prior to the mechanical brakes taking effect in two discrete steps.

• Step 1 is a gentle "engine braking" effect when the throttle is released.

• Step 2 kicks in when the brake levers are initially pressed, just prior to the mechanical brake pads, adding more motor braking when the brake levers are engaged fully.

This system not only saves brake pad wear, but also transfers energy back into the bike's battery, to maximize range. It's a win-win! The magnitude of regen braking is adjustable in the UBCO Rider's App to suit the rider's preferences and use case.

Tip: The brake lever angle can be adjusted using the screws on the brake lever mount. Ensure they're retightened to 7Nm torque setting.

6. LCD DISPLAY

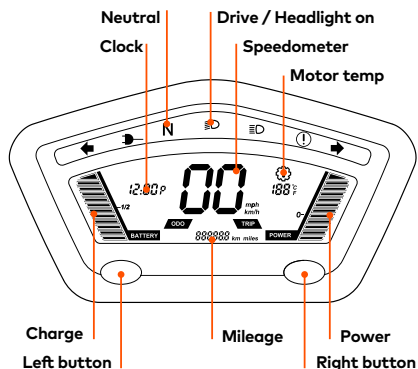

- ← Left indicator
- Right indicator
- ⚡ Charge required
- ⚠ Warning
- ⚡ Lights on / Lo beam
- ⚡ Odometer displayed
- ⚡ Lights on / Hi beam
- ⚡ Trip meter displayed

6.1 Warning Light

If there is a system issue, the warning light will flash and an alert code will be displayed in the odometer area. Find more information in the UBCO App or contact your local UBCO support line.

Some basic alert codes are provided on page 30.

6.2 Charge Level

Accurate state of charge (SOC) is displayed on the left side of the display, split into 12 segments. The charge level is split up into 12 segments with a halfway indicator. The charge required indicator will light up when battery SOC is getting low.

6.3 Power Output Meter

This displays the real-time power output to the motors. Any bars shown above the 0 mark represent power output to the motors and any bars shown under the 0 mark represent power input to the battery through regenerative braking.

6.4 Odometer and Trip Meter

To select between odometer (ODO) and trip meter (TRIP) view, press the left button. To reset the trip meter, press the left button for 2 seconds while TRIP is showing.

6.5 Switch from Metric to Imperial

To select between metric and imperial units for the speed, odometer, and trip meter, while ODO is showing, hold down the left button for 2 seconds. To change between Celsius and Fahrenheit, press the right button.

6.6 To Change the Clock

1. Hold down the right button until the time numbers start flashing.
2. Press the right button to change between hours and minutes.
3. Press the left button to cycle through numbers.
4. Hold the right button until the numbers stop flashing to set the time.

7. ADJUSTABLE SUSPENSION

The front and rear suspensions have adjustable rebound controls that change the rate at which the suspension re-extends after an impact. They also feature spring preload adjustment that are helpful for setting the loaded ride height of the vehicle and help determine the suspension's ability to prevent bottoming out (AKA setting the Sag).

These adjustments allow the rider to set the loaded ride height for various use cases and terrains to improve the handling and capability of the vehicle. For more demanding terrain, or higher load carrying capacity, we recommend increasing the preload to prevent harsh bottom out forces. See page 19 for recommendations for various riding situations.

7.1 Front:

Rebound speed is adjusted on the right-hand side of the fork crown. Twist the dial clockwise to slow the rebound; counter-clockwise to speed it up. On the left side of the fork, the spring preload is adjusted. Twist the dial clockwise to increase the spring force; counter-clockwise will lessen the spring force.

Spring Preload

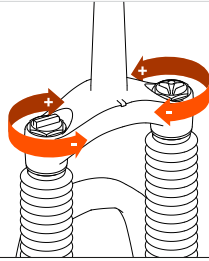
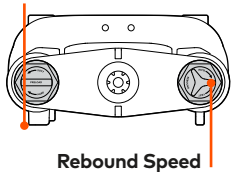

7.2 Rear:

Rebound control can be adjusted using the red dial at the top of the spring. Twist the dial counter-clockwise to slow the rebound; clockwise speeds it up (this is opposite to the front fork).

To adjust the rear spring preload, wind the disk at the base of the spring. Twist clockwise to lessen the spring force; twist counter-clockwise to increase the spring force. The rear suspension preload and rebound controls should be set equally on both sides of the bike.

Rebound

Preload

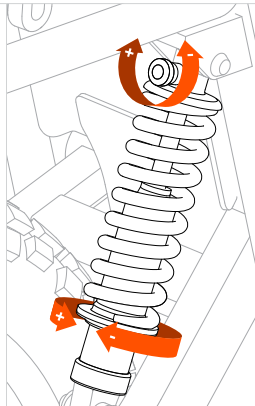
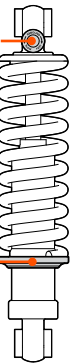

7.3 Suspension Recommendations

	FRONT REBOUND	FRONT SPRING	REAR REBOUND	REAR SPRING
On-Road Rider Only (90kg/198lb)	Max fast	Full soft	Max fast	20mm thread exposed
On-Road + Load (125kg/276lb)	Max fast	1 full turn to hard	4 clicks towards slow	20mm thread exposed
Off-Road Rider Only (90kg/198lb)	Max fast	Full soft	2 clicks towards slow	30mm thread exposed
Off-Road + Load (90kg/198lb)	Max fast	1 full turn to hard	6 clicks towards slow	30mm thread exposed



IMPORTANT: If riding on a hard surface while off-road, such as hard, dry ground or tracks, adjust the suspension to on-road settings.

7.4 Wheels

Each tire on your 2x2 uses a standard, car style valve for inflation and deflation.

The 9-gauge stainless steel spokes in a tangential double-crossed pattern provide extra wheel strength on DOT compliant aluminum rims.

Tire Size: Supplied with 17x2.75" multi-use tires, balanced between street performance and off-road grip (ECE and DOT compliant). Only use tires with a minimum load capacity of 37 and minimum speed category of B.

Recommended Tire Pressure: 207 kpa | 25 psi or as specified on the tire.

8. ACCESSORY LUGS

The 2×2 features 19 individual accessory lugs that are conveniently located around the bike frame and racks to provide flexibility and adaptability. The lugs use standard M8 nuts and bolts for attaching tie downs, mounts, and accessories. Fit UBCO accessories from pannier bags to cargo decks, or use the adapter pack to create your own custom attachments.

Inside each lug is a cavity to hold an M8 nut in place, preventing it from spinning as the bolt is tightened or loosened.

The front rack is attached via two lugs at the front of the main frame. These lugs can be utilized for other attachments when the front rack is removed.

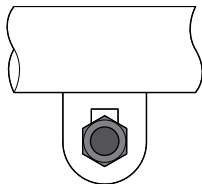

Front View

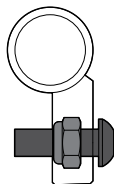

Side View

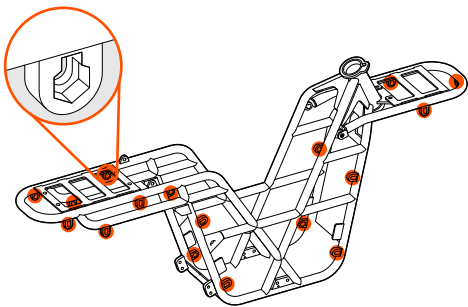

9. YOUR BATTERY

The UBCO 2×2 battery and connections are made to do the hard work. Tested to an IP66 standard, the battery is fully water and dust resistant.

A solid work horse, the Li-ion battery delivers a large capacity in a sturdy package. Each 2×2 battery is constructed from high quality LG 18650 Cylindrical Cells, mounted into cell holders, sealed within an alloy case, and screwed shut.

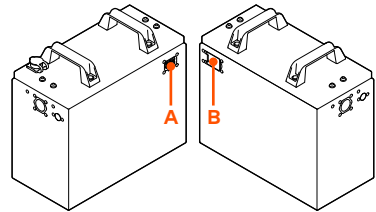

A. Main Power Output

B. Charge Socket

UBCO batteries are UN38.3 certified and the charger is UL/CE certified to provide safe operation, use, and transit. All this results in a robust battery that can handle the ride – and all the mud and dust.

When placing the battery into the bike, ensure the main power output socket is located on the right-hand side of the battery (when sitting on the 2×2). The charge port is located opposite side. Be sure the plugs and ports are clean before attaching.

9.1 Charging

Depending on capacity and remaining charge, the battery can take up to 6 hours to fully charge.

9.2 Checking the Charge

To check battery capacity, ensure it is plugged in to the 2×2 and press the key fob to turn the bike on. The charge meter on the left hand side of the LCD display will indicate the remaining charge level. Charge level is also available on the UBCO App.

The yellow 'Charge Required' light at the top of the display will also illuminate when the charge is low.

9.3 How to Charge the Battery:

- A. Turn off the 2×2 using the key fob.
- B. Plug the charger into the charge socket on the battery and twist to lock.
- C. Plug the provided charger into any standard wall socket and switch on at the wall (where required).
- D. The LED indicator lights on the charger will signal:

GREEN: Battery is fully charged

RED – Solid: Charging as normal

RED – Flashing: No battery connected

BLUE – Solid: Battery voltage fault

BLUE – Flashing: Reverse polarity

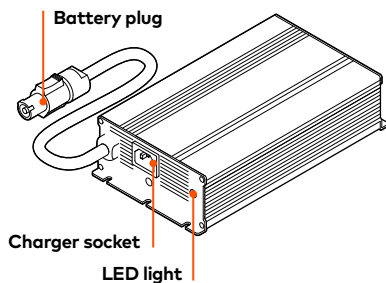

If a charge error occurs, disconnect the charger from the battery and wall socket. Reconnect. If flashing persists, contact your UBCO dealer.

When charging:

- Keep away from any sparks or flames.
- Install a smoke alarm near your charging area. Do not charge if cables, charger, or battery are damaged.
- Use charger in dry, indoor conditions only and with adequate ventilation.

When finished charging:

- Replace the waterproof cap over the charging socket on the battery.

! **WARNING:** Only use the charger under cover and on a clean, dry surface; the charger is NOT water resistant.

! **WARNING:** Never store the battery in an uncharged state. Doing so can void the warranty.

9.4 Removing the Battery

The 2×2 SE's battery is interchangeable with other UBCO GenX5 2×2 batteries, meaning that if you have more than one, you can swap them out to avoid charging downtime. Extra batteries are available from UBCO Ltd or your UBCO dealer.

! **WARNING: HEAVY OBJECT**
The batteries weigh between **14-18kg / 30-40lbs**. To avoid muscle strain or back injury, use proper lifting techniques.

! To operate properly, the **plug and sockets** need to stay **clean** and in **good condition**. If the battery is removed, ensure that the battery plug is reinstalled correctly.

9.4 Removing the Battery

- A. Turn off the 2×2.
- B. Remove the battery strap and power plug.
- C. Using the securing key, unfasten the lock located on the rear right-hand side of the battery.
- D. Lift the seat. Lift the battery with two hands.
- E. Store on a stable, cool, dry surface.

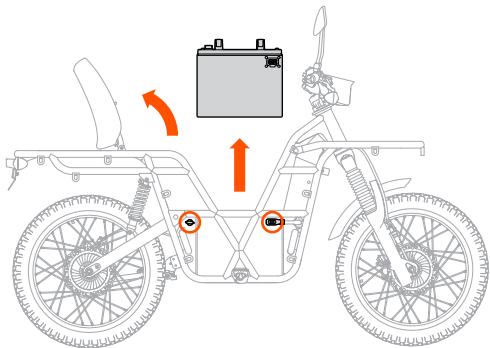

9.5 Battery Care & Safety

The lithium-ion battery and charger are designed to work exclusively with the 2×2. Do not attempt to use any battery or charger other than those supplied by UBCO. Extra batteries and chargers can be purchased from UBCO Ltd or your UBCO dealer.

- Lithium-ion batteries do not suffer from the same charge memory problems as other batteries, so they can be topped up at any time.
- Charge your battery at least once a month to ensure its health.
- Secure the battery in place when riding.
- Do not drop the battery into the 2×2 from a height. Lower it into place carefully.

- Do not submerge the battery or the 2×2.
- Store in a cool place indoors when not in use.
- Do not burn the battery or place it near heat sources above 80°C / 176°F.
- Keep away from children.
- Do not attempt to open the battery. This will void the warranty.
- Always charge your 2×2 indoors, protected from water, and at a temperature between 0-40°C / 32°-104°F. Charging the battery outside of this temperature range could damage your battery or affect performance and life span.
- As lithium is deemed a Class 9 Dangerous Good, the battery must always be charged on a non-flammable surface (cement floor, steel shelf, etc).
- If storing the battery for an extended period, ensure it has between 50% and 90% charge. Storing the battery with either full or too low a charge can cause cell damage, reducing its life.
- If you have any issues, please contact your local service provider or contact UBCO directly.

10. RIDING SAFETY

Due to its electric drive motors, the UBCO 2×2 is silent when on and very quiet in operation. When not in use, turn the bike off to prevent accidental throttle activation.

10.1 General Safety

- The 2×2 is nearly silent, always assume you are invisible to all other road and off-road users.
Your life depends on it.
- Be aware of your surroundings, other people, animals, and other vehicles. Ride to the conditions.

- Ride the 2×2 within its loading and gradient limits as described in this section.
- Follow your local road laws and regulations, both on and off-road, and ride within your limits.
- Never operate the 2×2 when fatigued, impaired, or under the influence of drugs or alcohol.
- Wear a well-fitting helmet, securely fastened, that provides good visibility and meets law requirements.
- Wear appropriate apparel such as close-toed shoes, gloves, and eye protection.

10.2 On-road Safety

- Inexperienced riders must take care and practice before entering traffic.
- Watch for changes in traffic.
- Check your blind spots and signal when turning or changing lanes.
- Abide by your local riding laws, regulations, and posted speed limits.
- Be mindful of other road users; never ride in a way that could cause harm to others.
- Use your horn appropriately.
- Take extra care riding in wet, frosty, or windy conditions, and when riding over road markings.

10.3 Off-road Safety

- Watch for changes in terrain.
- Abide by local off-road riding laws and regulations.
- Use your horn as a warning signal where appropriate.
- Do not 'wheelie' or jump the 2×2. This can damage the hub motors, causing gear shock

when the motor accelerates rapidly in the air and then decelerates instantly when it hits the ground again.

- The 2×2 is not designed to be a MX/Motocross bike. Using the 2×2 like an MX bike may damage the drive system and will likely void the warranty.
- The battery, motors, and electrical components are protected against mud, heavy rain, surface water, and shallow water crossings. They are not protected against submersion. The 2×2 should not ford water deeper than the axles.
- If you are unsure about the type of riding you are doing, please check with your service provider or the team at UBCO and we can advise you.

10.4 Kickstand Safety

The UBCO 2×2 comes with a manually retracted kickstand that must be retracted before the throttle can be activated. It has a switch so the 2×2 cannot be ridden with the stand down. When retracting the kickstand, it is important to keep your legs and other body parts clear of the kickstand's path of movement.

11. LOADING THE 2×2

11.1 Loading Safety

Improperly loading your 2×2 can affect its stability and handling. Ride with caution when your 2×2 is loaded up.

We recommend you do not exceed 150kg, including your body weight and cargo.

Rider Only ≤ 100kg

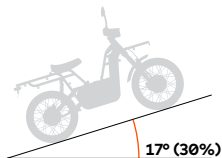

Rider + Cargo 100-150kg

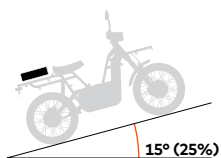

Rider + Cargo ≤ 100kg

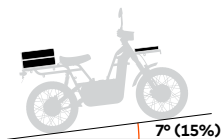

Load Limits

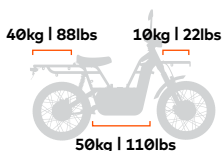

Do not put your full weight on the kickstand. It is rated to support the 2×2 and a 50kg load. If load exceeds 50kg, support the 2×2 while loading.

Balance your load evenly. Do not impede any moving parts on the 2×2. Do not obscure lights, suspension, steering, or the view from your wing mirrors.

NOTE: These load limits are estimated suggestions based on testing. Each rider's abilities and limitations should be considered when loading up the 2×2.

11.2 Riding with a Load

With a load up to 100kg / 220lbs, the max gradient is 15°/25%. With loads exceeding 100kg, maximum and continuous gradients must be reduced accordingly.

Estimated limits for various gradients are shown.

For perspective, Baldwin Street in Dunedin, NZ is the world's steepest street at 19° or 35% – so don't be afraid to tackle those hills!

11.3 Carrying the Bike

The 2×2 can be carried on a vehicle using a standard tow hitch-mounted carry rack.

- Remove the battery before transporting and carry batteries inside your vehicle.
- Lift the bike onto the rack and lock steering to avoid excess movement while traveling.
- Attach ratchet straps around both the towbar rack and the 2×2 frame through the center section of the bike (where it forms an X shape).
- Check the bike is secure before driving your vehicle.
- Ensure plugs and ports are clean before reinstalling the battery.



WARNING: HEAVY OBJECT – TWO PERSON LIFT REQUIRED

Bikes weigh between **50-53kg / 110-116lbs** with the battery removed.

To avoid muscle strain or back injury, use proper lifting techniques when moving and lift the bike slowly.

12. ALERT CODES

Your 2X2's intelligent electronics system provides valuable information while you ride, displayed on the LCD dashboard and/or the UBCO rider's app. This system alerts you of any issues or concerns (often temporary) so we recommend regular checks to ensure your 2X2 is operating as effectively and efficiently as possible. There are two types of codes:

- **Cautions:** These start with C-XXXX and are labeled as cautionary as they will not stop the bike from operating. They still require attention, as the bike may no longer meet safety or compliance standards.
- **Faults:** These start with F-XXXX and relate to a specific fault on the bike that may lead to incorrect operation. They require immediate attention and may require servicing by an UBCO-certified technician.

In addition, the first digit of the code indicates if applicable to the front or the rear of the bike:

- **Front:** Codes start with either C-1XXX or F-1XXX.
- **Rear:** Codes start with either C-2XXX or F-2XXX.

The following table provides a list of potential codes and the recommended remedial actions.

Lighting Systems

C-0001, C-0002, C-0003, C-0004, C-0005, C-0006

Carry out basic inspections.⁽¹⁾

If fault persists, contact your local service agent.⁽²⁾

Battery Systems

C-1058, C-2058, C-1061, C-2061, F-1011, F-2011

Carry out basic inspections.⁽¹⁾

If fault persists, contact your local service agent.⁽²⁾

Hub Motor/Controller System

C-1061, C-2061, C-1062, C-2062, C-1063, C-2063, F-1001, F-2001, F-1015, F-2015, F-1016, F-2016, F-1017, F-2017, F-1018, F-2018, F-1028, F-2028, F-1052, F-2052, F-1053, F-2053, F-1056, F-2056, F-1057, F-2057, F-1064, F-2064

Carry out basic inspections.⁽¹⁾

If fault persists, contact your local service agent.⁽²⁾

Throttle/ECU System

C-0011, F-0001, F-0003, F-1024, F-2024

Carry out basic inspections.⁽¹⁾

If fault persists, contact your local service agent.⁽²⁾

Impact/Shock to wheel

F-1022, F-2022

Can be caused by an impact/shock loading to a wheel.

Cycle power to clear fault memory and continue riding.

If fault persists, contact your local service agent.⁽²⁾

High Motor Temperature

F-1023, F-2023

Can be caused if the hub motors become excessively hot.

Stop riding and allow motors to cool before continuing on.

If fault persists, contact your local service agent.⁽²⁾

⁽²⁾ Basic Inspections:

- Check and confirm charge level of the battery.
- Check battery connection for cleanliness and security.
- Visually inspect relevant components for damage or signs of wear and tear.
- Inspect relevant wiring harnesses and connectors for damage.
- Check / update firmware using the UBCO rider's app.
- If you're unsure about anything contact your local service agent or support@ubcobikes.com.

⁽²⁾ Visit: www.ubco.com/dealer-locator for a full list of UBCO Service Agents.

13. FAQ

We've collected together a few common problems that have a simple fix. See more frequently asked questions on our website at ubco.com/FAQ.

My bike won't turn on.

- Check that your 2×2 battery is charged up.
- Check that the battery in the key fob has a charge or put in a new CR2032 cell battery.
- Check that the battery connection is clean & fully plugged in.

My bike is turned on but it won't go.

- Check the kickstand is retracted.
- Check the kill switch is disengaged.
- Check the motor cables are properly connected.
- Check the motor temperatures on the UBCO App. If they're over 125°C or 255°F, wait a few minutes for them to cool down before resuming your ride.
- Check the UBCO App for any fault codes (see common codes on the previous page).

I can hear a rattling while I'm riding.

- Ensure all load and attachments are secure.
- Check the spoke tension and tighten if required.
- Check all fasteners are tightened.
- Check the brake rotors for dirt or debris.
- If you're still hearing something strange, there could be a more serious problem.
- Get home and call us or your local dealer for assistance.

My bike is on and going but the lights aren't working.

- Check your settings via the UBCO App. The LIGHTS setting allows the lights to be turned off or disconnected.

I can't reach my expected top speeds on flat ground.

- If you've recently updated your UBCO App, make sure location services are turned on. The app is location sensitive and can drop the maximum speed limit incorrectly after an update if your location is not turned on.
- Speed is automatically limited to 45kph when riding in the European Union.
- If the motors are overheating, they will reduce power. Check your UBCO App – if the motor temperature is over 95°C or 200°F, stop riding for a few minutes and allow them to cool.

The front wheel is losing traction uphill.

- Unlike a gas-powered motorcycle, where you might lean back to give the rear wheel more traction, the 2×2 is powered by both wheels. When riding uphill, shift your weight forward to ensure the front wheel gains traction and can pull you up the hill.
- Ensure your load is evenly distributed and does not exceed load limits.

What if my charge runs out while I'm away from the charger?

- Pay attention to your charge level while riding. If you're not sure that you'll have enough charge to make it home, reduce your power settings or switch the bike into Learner Mode using the UBCO App. This will lower your speed and reduce power consumption, which will extend your range.
- Find a hill to ride down with the brakes on to regenerate power back into the battery. That regenerated power could allow you to ride on flat sections again.

Need help?

- If you suspect your bike may be damaged or is functioning improperly, contact UBCO on support@ubcobikes.com or reach out to your technician for assistance.
- For a list of UBCO Authorized Dealers and Certified Technicians for sales and service, please see our website www.ubco.com/dealer-locator.

14. MAINTENANCE

It's important to keep your 2×2 in a good working order so it's ready to go when you are. To ensure it's always in the best condition possible, you should clean and service your 2×2 regularly.

Incorrect cleaning methods can void your warranty, so take care and make sure you follow these points.

Do:

- Clean your 2×2 after each day of use, especially when exposed to dirty terrain or salt water. If you are using the 2×2 in a clean environment, this may not be necessary.
- Before cleaning, turn the 2×2 off. Ensure all power outlets, including the battery, have their rubber seals securely in place. **The battery should be plugged into the 2×2 while cleaning.**
- Clean the 2×2 with a low pressure hose and soft automotive cleaning brush or sponge.

Do Not:

- Do not water blast or use a high pressure hose on the 2×2.
- Do not submerge electrical parts – they are protected from the rain and splashes, but should not be left in water.
- Do not use cleaning products that are not specifically designed for cars or motorcycles. They may contain ingredients that could scratch the finish or harm components of the 2×2.

14.1 Replacing the Key Fob Battery

Remove the silicone sleeve. Turn the key fob over so the button faces down. Put a flat screw driver into one of the provided slots and gently rotate to open.

Slide the battery out and replace with a new CR2032 battery, observing polarity.

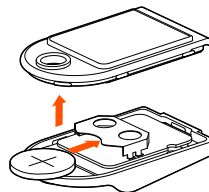

Position the rear plate over the base, taking care to replace the rubber seal, and push to click into place. Replace silicone sleeve.

14.2 Servicing Schedules

We recommend a 24-month service schedule. The 2×2 should be serviced at the indicated mileage or time, whichever occurs first. After the first 10 hours of riding you should get an initial, complimentary check over your bike from your dealer.

Insist on only genuine UBCO parts being installed in your 2×2 to ensure validity of the warranty. Regular servicing should only be carried out by an UBCO certified technician or dealer.

Standard Use

The 2×2 should be serviced at the indicated mileage or time, whichever occurs first:

- After the first 10 hours: First Complimentary Service
- 10 weeks / 2,000km / 1,242mi
- 6 months / 4,000km / 2,485mi
- 12 months / 8,000km / 4,970mi
- 18 months / 12,000km / 7,456mi
- 24 months / 16,000km / 9,941mi

Once you have completed your 24 month service, we recommend you continue to get your 2×2 serviced every six months.

Heavy Use

Heavy use conditions such as farming require a more robust maintenance schedule:

- After the first 10 hours: First Complimentary Service
- 4 months / 100hrs / 1,500km / 932mi
- 7 months / 200hrs / 3,000km / 1,864mi
- 10 months / 300hrs / 4,500km / 2,796mi
- 13 months / 400hrs / 6,000km / 3,728mi
- 16 months / 500hrs / 7,500km / 4,660mi
- 19 months / 600hrs / 9,000km / 5,592mi
- 22 months / 700hrs / 10,500km / 6,524mi
- 25 months / 800hrs / 12,000km / 7,456mi

Once you have completed your 25 month service, we recommend you continue to get your 2×2 serviced every three months. For specific service requirements tailored to your situation, please contact your service technician.

15. LIMITED WARRANTY

UBCO warrants to the original purchaser that the Products shall be free, under normal use and maintenance, from any defects in material or workmanship for the warranty periods set out on our website (www.ubco.com/) subject to the qualifications, exclusions, conditions, and limitations set out in this warranty statement. Where warranty conditions are met, defective Products or parts will be repaired or replaced at UBCO Limited's discretion.

Consumer Law

New Zealand: The Consumer Guarantees Act 1993 may apply to the transaction covered by this warranty. In the event that the Act applies, this warranty is to be considered as an express guarantee for the purposes of the Act. Where the terms of the warranty and the provisions of the Act conflict, the provisions of the Act will prevail.

The general exclusion, Limitations and Specific Category exclusions that are contained in this warranty do not in any way restrict or limit any liability that UBCO Limited may have under the Act. However, this warranty and any resultant express guarantee will be subject to the qualifications and limitations of the Act. This warranty in no way limits or affects UBCO Limited's obligations to comply with section 6, 9 or 12 the Act.

Australia: Our goods come with guarantees that cannot be excluded under the Australian Consumer Law. You are entitled to a replacement or refund for a major failure and compensation for any other reasonably foreseeable loss or damage. You are also

entitled to have the goods repaired or replaced if the goods fail to be of acceptable quality and the failure does not amount to a major failure.

In the event that the Competition and Consumer Act 2010 applies, this warranty is to be considered as an express guarantee for the purposes of the Act. Where the terms of the warranty and the provisions of the Act conflict, the provisions of the Act will prevail.

United States: All other conditions or warranties, which might otherwise be implied by statute or common law, are expressly excluded to the maximum extent permitted by law.

European Union: Our goods come with guarantees that cannot be excluded under each national legal act (of each member state) which implements the guarantees specified in the Consumer Rights Directive 2011/83/EU. You are entitled to a replacement or refund for a major failure and compensation for any other reasonably foreseeable loss or damage. You are also entitled to have the goods repaired or replaced if the goods fail to be of acceptable quality and the failure does not amount to a major failure. Please also be aware that your rights in terms of goods guarantees are limited to only those specified in the above-mentioned national legal act and nothing else is contractually implied.

The expiration term of these rights shall coincide with the term specified in each national legal act (of each member state). Where the terms of the warranty and the provisions of the national legal act conflict, the provisions of the national legal act will prevail.

United Kingdom: Our goods come with guarantees that cannot be excluded under the Consumer Rights Act 2015. You are entitled to a replacement or refund for a major failure and compensation for any other reasonably foreseeable loss or damage. You are also entitled to have the goods repaired or replaced if the goods fail to be of acceptable quality and the failure does not amount to a major failure. Please also be aware that your rights in terms of goods guarantees are limited to only those specified in the above-mentioned national legal act and nothing else is contractually implied.

For goods purchased in England or Wales, these rights expire six years from delivery of the goods and for goods purchased in Scotland, these rights expire five years from delivery of the goods. Where the terms of the warranty and the provisions of the Act conflict, the provisions of the Act will prevail.

Maximum Liability

To the maximum extent permitted by law, UBCO's maximum liability in contract, tort, equity, statute, regulation or otherwise for any loss, damage, or injury directly or indirectly resulting from any defect in, or non-compliance of, or use of, the Product will not in aggregate exceed the price (excluding GST) for the Product that caused the loss, damage or injury.

MAINTENANCE OBLIGATIONS

Whilst UEVs and Batteries have fewer moving parts than combustion engine vehicles, they still require maintenance to ensure their continued safe operation. Every product will need scheduled maintenance and care to ensure your warranty is maintained. This will increase the product's lifespan and reduce lifetime maintenance.

Owner's Obligations

Where a User Manual is supplied with a Product, the purchaser of the Product and ultimate end user must review the Manual to understand the operations, limitations, maintenance, and care instructions for the Product.

- Ensure that the vehicle has scheduled servicing according to the service schedule (turn page over to view service schedules).
- Such servicing should be undertaken at an authorised UBCO technician.
- The owner is responsible for the maintenance obligations and must drop off and pick up the vehicle, at their own cost, to an authorised UBCO technician.

VEHICLE COMPLIANCE

It complies with the following country vehicle regulations:

- **Australia:** LA Class (Moped). This vehicle was manufactured to comply with the Australian Motor Vehicle Safety Standards Act 1989.
- **New Zealand:** LA Class (Moped). This vehicle was manufactured to comply with the Australian Motor Vehicle Safety Standards Act 1989, which is accepted in New Zealand.
- **United States:** This vehicle conforms to all applicable Federal Motor Vehicle Safety Standards (FMVSS) in effect on the date of manufacture. This is classified as a 'Motorcycle' with a 'Motor Driven Cycle' exception being under 5 BHP and having a maximum obtainable speed of 30mph.
- **UK/Europe:** L1e-B vehicle class. The vehicle was designed and manufactured to comply with the directives and regulations in effect on the date of manufacture for this vehicle class.

FCC COMPLIANCE

This equipment has been tested and found to comply with the limits for a Class B digital device, pursuant to part 15 of the FCC Rules. These limits are designed to provide reasonable protection against harmful interference in a residential installation. This equipment generates, uses and can radiate radio frequency energy and if not installed and used in accordance with the instructions, may cause harmful interference to radio communications. However, there is no guarantee that interference will not occur in a particular installation.

If this equipment does cause harmful interference to radio or television reception, which can be determined by turning the equipment off and on, the user is encouraged to try to correct the interference by one or more of the following measures:

- Reorient or relocate the receiving antenna.
- Increase the separation between the equipment and receiver.
- Connect the equipment into an outlet on a circuit different from that to which the receiver is connected.
- Consult your UBCO technician or an experienced radio/TV technician for help.

Before riding your 2x2, always complete the pre-ride checklist.

Hop on and retract the kickstand

STEP 3

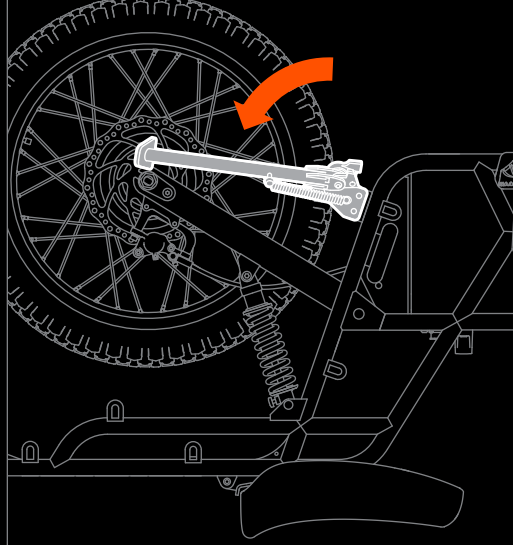

If you're ready to ride, hop on the bike and retract the kickstand. You won't be able to drive with the kickstand out.

For your safety, please wear a helmet and appropriate riding gear.

Engage the bike and go!

STEP 4

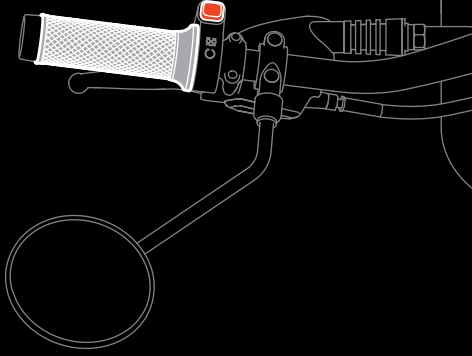

Press the red button to enable Drive. The headlight will turn on. Twist the throttle towards you to go.

How to Get Your 2x2 Started

STEP 1

Turn on the bike

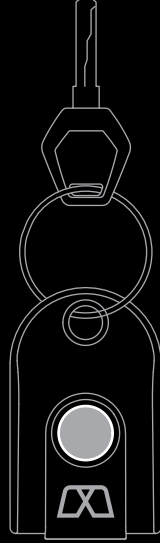

Hold the key fob button for 1.5 seconds to turn the bike on and into Neutral. The display will turn on and N is illuminated.

STEP 2

Get connected



Download the UBCO Rider's App to enhance your 2x2 experience. Scan the code or search UBCO in your app store.

PRE-RIDE CHECKLIST

DO NOT ride the 2x2 if it is materially

defective, damaged, or missing safety-



related equipment. Physically check off

each of the above before you ride.

6. Horn

Sound the horn to ensure it's working.

7. Tires

Check the condition and pressure of the tires.

8. Loose Fixings

Ensure all the fixings (nuts & bolts) are done up correctly and securely.

9. Load

Ensure all functional parts of the bike are not obstructed by any load you may be carrying.

10. Safety Wear

For your safety, please wear a helmet and appropriate riding gear.

11. Keys

Remember to take your key fob with you (unless you've turned security mode off).

1. Battery

Ensure there is enough charge to carry out your work or journey. Check that the battery strap is secured tightly.

2. Brakes

Check the brakes are working and inspect their brake pads for wear.

3. Lights

Ensure the headlights, rear light, brake light, and turn signals are working.

4. Kickstand

Check the kickstand is functional, especially if the bike is loaded up, and check it stays up when retracted. Retract the kickstand before riding.

5. Mirrors

Check they are properly fastened and adjusted for proper viewing.

2x2 Electric Adventure Motorbike

QUICK START GUIDE
MODEL: 2x2 SE 2023

FLIP BOOK OVER TO
READ USER MANUAL

UBCO